

EXTENSOMETERS

EXTENSOMETERS ARE USED FOR MEASURING AND/OR CONTROLLING STRAIN IN TENSION, COMPRESSION AND FATIGUE TESTING APPLICATIONS. MEASURING ON THE SPECIMEN SIGNIFICANTLY INCREASES THE RELIABILITY OF YOUR DATA. RELYING ON THE CROSSHEAD OR ACTUATOR MOVEMENT OF YOUR MATERIALS TEST SYSTEM WILL MEASURE TOO MUCH – MACHINE DEFLECTION, GRIP DEFLECTION, AND POSSIBLE SLIPPAGE ARE ALL CAPTURED IN THE LOAD TRAIN DISPLACEMENT MEASUREMENT.

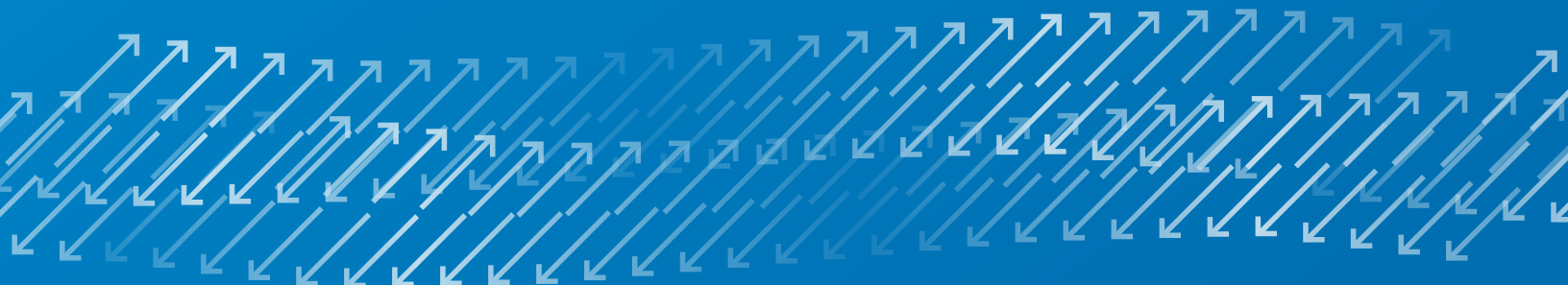

Extensometer Table of Contents

| | |
|---|-------|
| Introduction | 3 |
| Extensometer Application Index | 4 |
| Extensometer Functional Index | 5 |
| 6 Things to Remember when Selecting an Extensometer | 6-9 |
| Axial Extensometers | 10-23 |
| High Temperature Extensometers | 24-26 |
| Specialty Extensometers | 27-31 |
| MTS Advantage Optical Extensometer (AOX) | 32-33 |
| MTS Advantage Video Extensometer (AVX) | 34-35 |
| Laser Extensometer | 36 |
| Other Applications | 37 |
| Clip-On Displacement Gages | 38 |
| Displacement Gages | 39 |
| Extensometer Calibrator | 40 |
| MTS Direct Current Potential Drop (DCPD) Solution | 41 |

Extensometers

Accuracy is Key

Pioneered to Perfection

MTS pioneered and perfected the cross-flexure design that ensures true center point bending of its extensometers. Precision, resistive-type foil strain gages are bonded to the MTS cross-flexure to form a 4-arm fully active Wheatstone bridge.

- » Bridges of 350 ohms and 1000 ohms are used
- » Output, depending on the unit is 2 mV/V to 6 mV/V
- » Nominal excitation range from 5 to 12 V DC for room temperature testing

HIGH PERFORMANCE, HIGH QUALITY

- » Proven stability over 30+ years of usage
- » Built-in over-travel protection provides repeatable accurate data from test initiation through specimen failure
- » Quickly and accurately set-up your extensometer using the zero set pin or zero stop
- » Cross-flexure design ensures the strain gages are subjected to true center point bending and the same force, time after time
- » Small, lightweight design – most are under 35 g mass

- » MTS extensometer models are available for both static and dynamic testing
- » MTS extensometers meet or exceed requirements for calibration according to ASTM E83 Class B1 and ISO 9513 Class 0.5 standards

CAN'T FIND WHAT YOU NEED?

- » Our extensometer portfolio contains hundreds and hundreds of additional dynamic rated extensometers. Contact your local sales representative or applications engineer to find the model that meets your exact needs
- » Custom models are also available upon request

MTS Extensometer Repair & Rework

Why go through the process of certifying a new extensometer when the one you have still does the job? Many of our extensometers survive tens of thousands of tests without a problem – so if the unit only needs a new zero set pin or cables let us repair it for you. Contact your local sales representative for details.

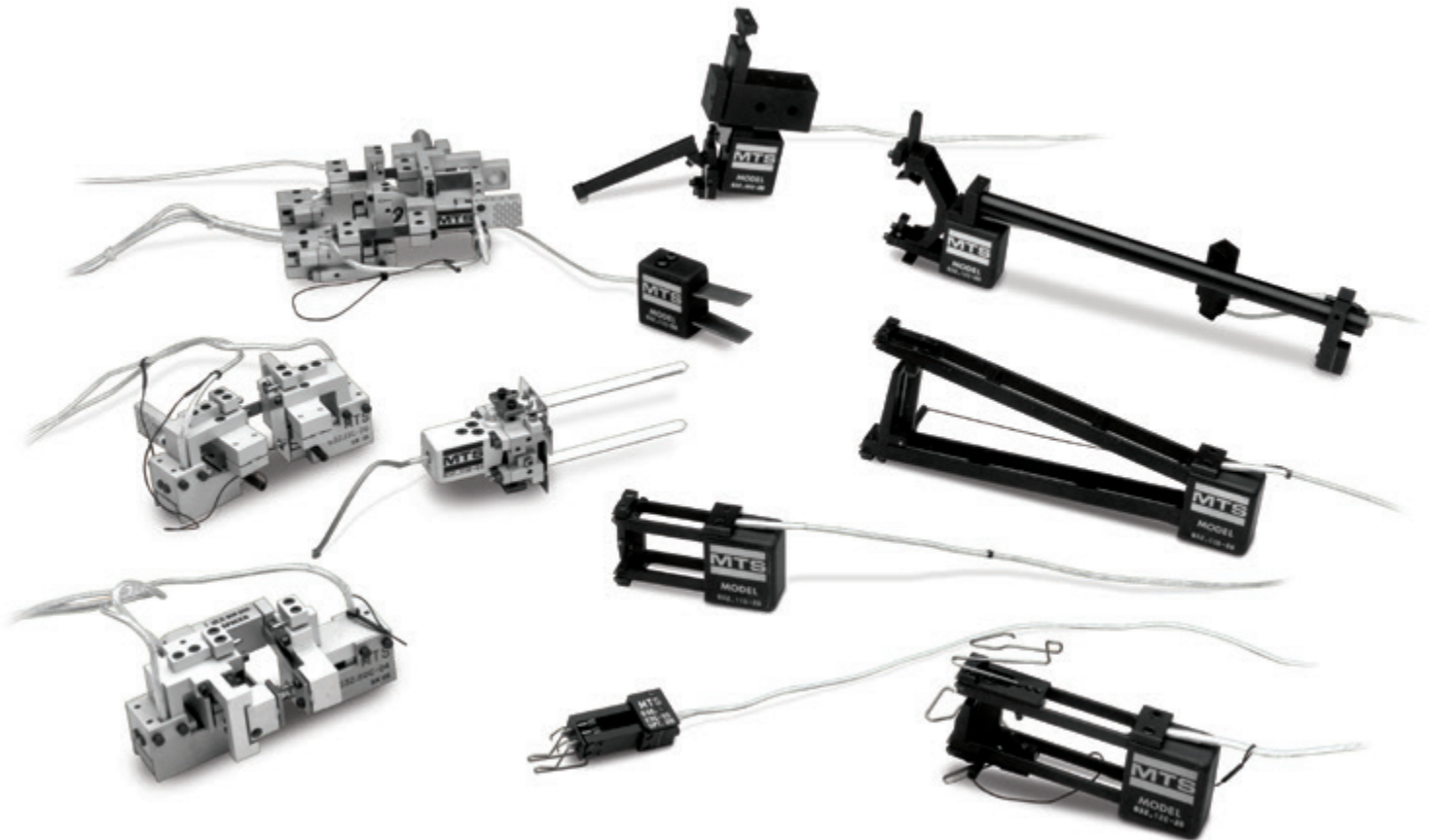

MTS has the broadest selection of extensometry in the world

Extensometer Application Index

Use this helpful index to determine which extensometers are best suited for your application. Please contact us for more information.

| Application | Extensometer Options | See Pages |
|--------------------------------------|--|--|
| Metals | | |
| Tensile (ASTM E8) | 632.13/.24 & 634.11/.12/.25/.28/.31; 635; FAX; AOX; AVX | 11, 12, 14, 15, 16, 19, 21, 32, 34 |
| Compression (ASTM E9) | 632.13/.26/.27 & 634.11/.12/.31; AOX; AVX | 11, 12, 13, 16, 32, 34 |
| KIC - Fracture Toughness (ASTM) | 632.02 ASTM Standard; 632.03 MTS Enhanced; 632.65 (High Temperature) | 38 |
| Pre-Cracking (ASTM E399) | 632.05 (High Frequency) | please call |
| JIC (ASTM E813) | 632.03 with Long Travel Option | 38 |
| Crack Growth - Bend (ASTM E399) | 632.03 | 38 |
| Fatigue Crack Growth (ASTM E647) | 632.03 with Long Travel Option; 632.05 (High Frequency) | 38 |
| High Cycle Fatigue | 632.27 (Low Strain) | 13 |
| Low Cycle Fatigue (ASTM E606) | 632.13/.18/.19/.20 & 634.11/.12/.31 & 632.50/.51/.53/.54 | 11, 12, 16, 24, 25, 30 |
| Low Cycle Fatigue (High Temp) | 632.50/.51/.57 | 24, 25, (please call for .57) |
| Low Cycle Fatigue (High Temp) | 632.53/.54 | 24 |
| Advanced Materials | | |
| Bend (MIL SPEC 1942, JIS 1601R) | 632.06 | 39 |
| Tensile/Compression | 632.26; FAX; AOX; AVX | 11, 21, 32, 34 |
| High Temperature (CMC's MMC's) | 632.5X | 24, 25 |
| Ultra High Temperature Bend | 632.70 | please call |
| Composites | | |
| Tensile (ASTM D3039) | 632.17/.85 & 634.11/.31; AOX; AVX | 12, 16, 27, 28, 32, 34 |
| Compression (ASTM D695) | 632.17 & 634.11/.31; AOX; AVX | 12, 16, 27, 32, 34 |
| ±45° Shear Test (ASTM D3518) | 632.17 & 634.11/.31; AVX | 12, 16, 27, 34 |
| Flexure (ASTM D790) | 632.06 & 634.11/.31 | 12, 16, 39 |
| Tension/Tension Fatigue (ASTM D3479) | 632.17/.85 & 634.11/.31 | 12, 16, 27, 28 |
| Plastics | | |
| Tensile (ASTM D638) | 632.17/.24/.85 & 634.12/.25/.31, FAX; 635, LX 500/1500; AOX; AVX; | 12, 14, 15, 16, 19, 21 22, 27, 28, 32, 34 |
| Rock Mechanics | | |
| Triaxial Comp. Strength (ASTM D2664) | 632.90/.92 | please call |
| Triaxial Creep (ASTM D4406) | 632.90/.92 | please call |
| Bio-Materials | | |
| Axial/Torsional | 632.29 & 634.11/.12/.25/.31, LX 500; FAX; AOX; AVX | 10, 12, 14, 16, 21, 32, 34 |
| Immersion Extensometer | 632.68/.80 | please call |
| High Temperature | | |
| Air Cooled | 632.79 | 31 |
| Water Cooled | 632.53/.54 | 24 |
| Uncooled | 632.51/.68 | 25 (please call for .68) |
| Hostile Environments | 632.53/.54/.70 | 24 |
| Fracture Mechanics | 632.10 & LX 500/1500 | 36 |
| Fracture Mechanics | | |
| Fracture Toughness | 632.02/.03; 632.65 (High Temperature) | 38 |
| Pre-Cracking | 632.05 (High Frequency) | please call |
| Bend | | |
| Displacement | 632.06 | 39 |
| Crack Growth | 632.03 | 38 |
| High Temperature | 632.70 | please call |
| Fatigue & Fracture | | |
| Crack Growth | 632.03 with Long Travel Option; 632.05 & 632.65 | 38 |
| High Cycle | 632.27 (Low Strain) | 13 |
| Low Cycle Mechanics | 632.13/.18/.19/.20 & 634.11/.12/.31 | 11, 12, 16, 30 |
| Low Cycle (High Temp) | 632.50/.51/.53/.54/.57 | 24, 25, 37 |
| Tensile/Compression Testing | | |
| Tensile | 632.13/.24 & 634.11/.12/.25/.28/.31; FAX; 635, AOX; AVX; | 11, 12, 14, 15, 16, 19, 21, 22, 32, 34 |
| Compression | 632.13/.26/.27 & 634.12/.25/.31; FAX; AOX; AVX; | 11, 12, 13, 16, 21, 32, 34 |
| Poisson's Ratio | 632.18/.19/.20/.23/.85 & 634.12/.25/.31; AOX; AVX | 12, 14, 16, 21, 28, 29, 30, 32, 34 |
| Elastic Limit | 632.26/.27/.29 | 10, 11, 13 |

Extensometer Functional Index

Axial Contact Extensometers

DYNAMIC MODELS (TENSION/COMPRESSION)

Metric Units

US Customary Units

| MODEL NUMBER | GAGE LENGTH | MEASURING RANGE: STRAIN (TRAVEL) | MODEL NUMBER | GAGE LENGTH | MEASURING RANGE: STRAIN (TRAVEL) | SEE PAGE |
|--------------|-------------|----------------------------------|--------------|-------------|----------------------------------|----------|
| 632.29F-20 | 3 mm | ±8% (±0.24 mm) | 632.29E-20 | 0.12 in | ±8% (±0.0096 in) | 10 |
| 632.29F-30 | 5 mm | -10%/+30% (-0.5 mm/+1.5 mm) | 632.29E-30 | 0.2 in | -10%/+30% (-0.02 in/+0.06 in) | 10 |
| 632.29F-30 | 6 mm | ±4% (±0.24 mm) | 632.29E-3X | 0.24 in | ±4% (±0.0096 in) | 10 |
| 632.26F-3X | 8 mm | ±6% (±0.48 mm) | 632.26E-3X | 0.3 in | ±6% (±0.018 in) | 11 |
| 632.26F-2X | 8 mm | ±15% (±1.2 mm) | 632.26E-2X | 0.3 in | ±15% (±0.045 in) | 11 |
| 632.13F-2X | 10 mm | ±15% (±1.5 mm) | 632.13E-2X | 0.5 in | ±15% (±0.075 in) | 11 |
| 632.26F-4X | 12 mm | ±9% (±1.1 mm) | 632.26E-4X | 0.5 in | ±9% (±0.045 in) | 11 |
| 632.27F-3X | 25 mm | ±2% (±0.5 mm) | 632.27E-3X | 1.0 in | ±2% (±0.02 in) | 13 |
| 632.27F-2X | 25 mm | ±4% (±1.0 mm) | 632.27E-2X | 1.0 in | ±4% (±0.04 in) | 13 |
| 634.11F-2X | 25 mm | +20%/-10% (+5 mm/-2.5 mm) | 634.11E-2X | 1.0 in | +20%/-10% (+0.2 in/-0.1 in) | 12 |
| 634.12F-2X | 25 mm | +50%/-10% (+12.5 mm/-2.5 mm) | 634.12E-2X | 1.0 in | +50%/-10% (+0.5 in/-0.1 in) | 12 |
| 634.25F-2X | 50 mm | +50%/-10% (+25 mm/-5 mm) | 634.25E-2X | 2.0 in | +50%/-10% (+1.0 in/-0.2 in) | 14 |
| 634.31F-2X | 10-50 mm | variable (+4 mm/-2 mm) | 634.31E-2X | 0.5-2.0 in | variable (+0.2 in/-0.1 in) | 16 |

MONOTONIC MODELS (TENSION ONLY)

Metric Units

US Customary Units

| MODEL NUMBER | GAGE LENGTH | MEASURING RANGE: STRAIN (TRAVEL) | MODEL NUMBER | GAGE LENGTH | MEASURING RANGE: STRAIN (TRAVEL) | SEE PAGE |
|--------------|-------------|----------------------------------|--------------|-------------|----------------------------------|----------|
| 635.25F-05 | 25 mm | +20% (+5 mm) | | | | 19 |
| 634.11F-5x | 25 mm | +20% (+5 mm) | 634.11E-5X | 1.0 in | +20% (+0.2 in) | 12 |
| 634.12F-5x | 25 mm | +50% (+12.5 mm) | 634.12E-5X | 1.0 in | +50% (+0.5 in) | 12 |
| 632.24F-50 | 25 mm | +100% (+25 mm) | 632.24E-50 | 1.0 in | +100% (+1.0 in) | 15 |
| 635.50F-05 | 50 mm | +10% (+5 mm) | 634.25E-5X | 2.0 in | +50% (+1.0 in) | 14, 16 |
| 635.50F-10 | 50 mm | +20% (+10 mm) | 634.28E-24 | 2.0 in | +100% (+2.0 in) | 15, 19 |
| 635.50F-25 | 50 mm | +50% (+25 mm) | | | | 19 |
| 634.25F-5x | 50 mm | +50% (+25 mm) | | | | 14 |
| 634.28F-24 | 50 mm | +100% (+50 mm) | | | | 15 |
| 635.100F-10 | 100 mm | +10% (+10 mm) | | | | 19 |

Typical material specimens

6 Things to Remember when Selecting an Extensometer

Extensometers are available in hundreds of models and multiple technologies, so selecting the correct one can be confusing. An easy way to remember the relevant criteria for extensometer selection is to think of the acronym S.T.R.A.I.N.

Specimen

Always start with the specimen. Knowing some specimen properties before starting a test will help you select the best test equipment.

IDENTIFY THE SPECIMEN'S GAGE LENGTH

Extensometer measurements are taken over the center of a tensile or fatigue specimen called the gage section. Typical material specimens have enlarged ends or shoulders for gripping and a gage section with a smaller cross-sectional area. The gage section is narrower than the ends to ensure that material deformation occurs along the length with a constant area cross section. Typically strain is measured over the middle 70-80% of the gage section. Gage lengths for contact extensometers typically range 3mm (0.12 in) to 100 mm (~4 in), with longer gage lengths available for specific applications like rebar testing.

Gage length extender kits modify the gage length of an existing extensometer to perform strain measurements at longer or shorter gage lengths.

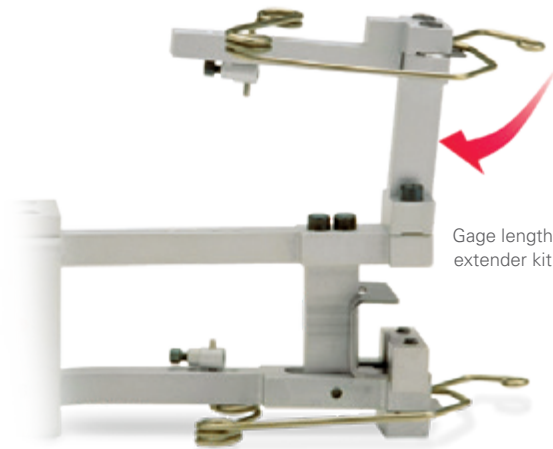

STRAIN

- » **S**pecimen
- » **T**est Method
- » **R**ange
- » **A**tmosphere
- » **I**SO/ASTM Calibration
- » **N**on-contact

CONSIDER THE SPECIMEN'S CROSS-SECTIONAL AREA

Whether the specimen is round or flat determines which type of knife edges to use with a contact extensometer. Straight knife edges are standard on many extensometers and recommended for testing round specimens. Knife edges with 3-point specimen contact are typically used when testing flat specimens. They include one single-point and one double-point contact knife edge. The 3-point specimen contact creates a plane, ensuring that your extensometer is in line with the axis of your test.

TAKE SPECIMEN PROPERTIES INTO ACCOUNT

The specimen must be strong enough to support the weight of the extensometer. Most room temperature extensometers are attached to the specimen using springs, rubber bands, or quick attachment kits. Look for lightweight extensometers that can be secured close to the specimen. The weight and length of the extensometer create an overturning movement that must be reacted to by the bottom knife edge. The knife edge on the bottom will dig into the specimen and the knife edge on the top will pull away. This problem worsens as gage length decreases. Next, look for knife edges that are sharpened on both sides – with a symmetrical point in the middle of the knife edge. These knife edges will last longer and are less likely to chip than asymmetrical options. Inexpensive extensometers are often heavier and longer, and they are more likely to bend the specimen or slip off.

PREDICT HOW YOUR SPECIMEN WILL FAIL

If you plan to test through specimen failure, be sure that your extensometer is up to the task. Many extensometers can be left on the specimen through failure, but backlash from high energy breaks can damage the most robust extensometer designs. Consider removing the extensometer before failure or using a non-contact extensometer if your specimen will break violently.

6 Things to Remember when Selecting an Extensometer

Test Method

After considering the specimen, knowing your test method helps narrow down extensometer options.

USE DYNAMICALLY RATED EXTENSOMETERS FOR STATIC TESTS, BUT NOT VICE VERSA

Not all extensometers are rated for dynamic testing. For example, if the frequency of the test cycle matches the natural frequency of the extensometer, the extensometer can begin to vibrate, increasing the noise in the strain measurement signal. Dynamically rated extensometers should be designed with high natural frequencies to avoid vibration. When testing at very high frequencies look for an extensometer that is lightweight with short arms.

Excellent dynamic extensometers use a cross-flexure design that was originally patented by MTS in the 1970s. A cross-flexure design ensures that the strain gages inside the extensometer are subject to true center point bending. Uniform stresses on the strain gage increase the fatigue life of the gage and ultimately the entire extensometer. The cross-flexure design has been employed by almost all dynamic extensometer manufacturers.

SAVE MONEY WITH STATIC ONLY EXTENSOMETERS

Extensometers used solely for static testing do not require the fatigue life of a dynamic extensometer. For example, a strain-gaged element that acts as a single cantilever beam is cheaper than a cross-flexure design because there are fewer components. The disadvantage is that there is more stress at the root of the beam and the bond holding the strain gage to the beam may wear out. Extensometers designed for static testing may have longer arms and are more likely to vibrate during dynamic testing.

Range

ESTIMATE HOW LONG YOUR SPECIMEN WILL TRAVEL TO IDENTIFY YOUR MEASUREMENT RANGE

Measurement range is the maximum travel an extensometer can stretch and still achieve accurate results. Measurement range is indicated either by an absolute measurement of distance or a relative measurement of strain range compared to the gage length. For example, a 50 mm gage length extensometer will have a measurement range of $\pm 10\%$ or ± 5 mm. Most premium contacting extensometers are designed with an over-travel protection that allows the device to extend slightly longer than its rated measurement range without damaging the components.

Atmosphere

Consider special needs when testing in extreme environments.

MOUNT THE EXTENSOMETER OUTSIDE YOUR FURNACE

It's hard to find a contacting extensometer that will work in a furnace above 540°C (1000°F). At these temperatures, the adhesives that attach the strain gage to the cross flexure start to fail and the test materials soften. Instead of quick attachment kits or rubber bands, extensometers used for testing at high temperatures are externally mounted with quartz or ceramic rods that extend into the furnace.

Mounting the extensometer outside of the furnace behind a heat shield protects the strain gage from thermal stress while still accurately measuring strain. Most models available include air- or water-cooling options. Water cooling is more effective at keeping the extensometer's sensing elements at a constant temperature and reducing the noise and thermal drift in the data measured. Some users also develop their own "homemade" heat shields to protect the extensometer from thermal drift in their outside environment.

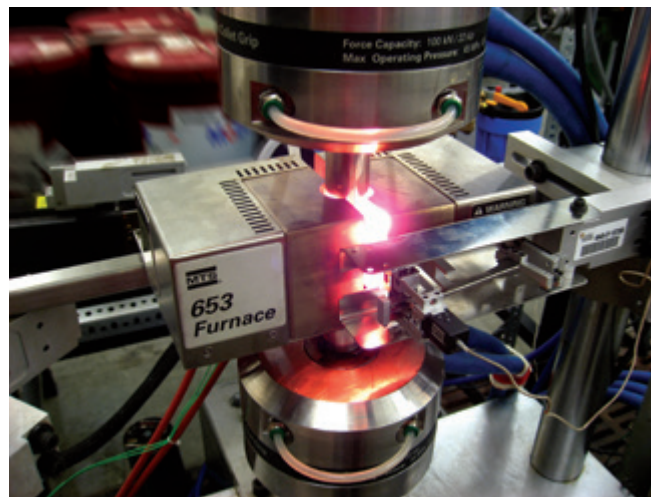

Extensometer mounted outside furnace

DON'T LET YOUR ROOM TEMPERATURE EXTENSOMETER GET TOO COLD

At extremely low temperatures, the adhesive that bonds the strain gage to the cross-flexure becomes brittle and may fracture. Special adhesives are used for extensometers designed for use in cryogenic applications.

6 Things to Remember when Selecting an Extensometer

SELECT THE ROD THAT ENSURES EXCELLENT CONTACT WITH THE SPECIMEN

Conical-point rods used in conjunction with dimples machined into the specimen provide very secure contact, but the dimples also create stress risers in the specimen. V-chisel rods are recommended for round specimens without dimples. Try to match the angle of the groove in the v-chisel rod as closely as possible to the circumference of your specimen. Chisel edges without v-grooves should be used when the specimen diameter is greater than 15 mm (0.6 in) or is flat.

USE AN LVDT-BASED EXTENSOMETER WHEN SUBMERSING IT IN A LIQUID

It's incredibly hard to keep a strain gage attached to a cross-flexure under water, so most manufacturers recommend LVDT-based units made of passivated stainless steel. Dissimilar metals should be avoided or coated with a non-permeable polymer. The LVDT should be hermetically sealed and well-supported.

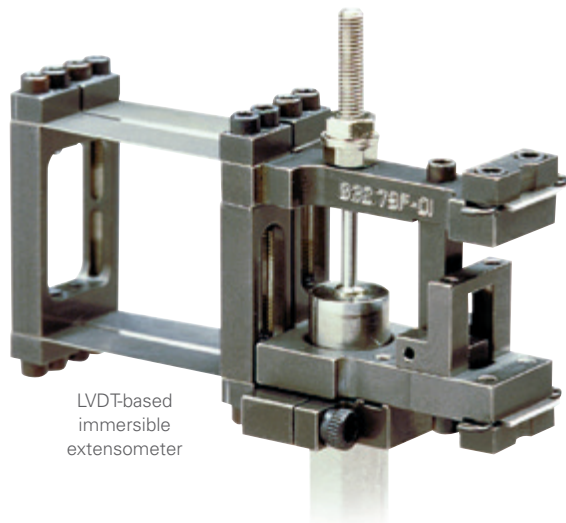

ISO/ASTM Calibration

CALIBRATE YOUR EXTENSOMETERS TO ISO 9513 OR ASTM E83 STANDARDS

Extensometers are classified based on the maximum error of strain and/or displacement compared to a known standard. ISO 9513 gives a class number (0.2, 0.5, etc.) where as ASTM E83 assigns a class letter (A, B1, B2, C, etc.). One primary difference between the ASTM and ISO standard is the fixed error allowed. For example, an ISO 9513 Class 0.5 calibrated extensometer may have a relative error of 0.5% displacement and a fixed error of $\pm 1.5\mu\text{m}$ and an ASTM E83 class B1 calibrated extensometer may have a relative error of 0.5% strain and a fixed error of 0.1 mm/mm. Refer to the ASTM and ISO standards for more details.

CHOOSE A TIGHT CLASSIFICATION FOR COMPOSITES TESTS, LOOSEN UP FOR POLYMER TESTING

New composites being developed for high-temperature aerospace applications are very stiff, low-strain materials. The best available extensometer classification should be used for tests of these materials.

Tensile testing of high-elongation **polymers** may be accomplished with a looser specification such as ASTM E83 Class C, where the relative error in percent strain is very small compared to the entire measurement range of the extensometer. Often the ASTM or ISO test procedure will define the extensometer class desired for testing.

Non-Contact

Initially, video and laser extensometers were used only when specimens were fragile or when the energy released by the specimen during fracture could break the extensometer. Today, these extensometers are rapidly replacing traditional contacting methods because they can provide more information.

Now video extensometers can track the movement of pixels in video recording and correlate that to strain measurement. Video extensometers with post processing capabilities even allow for measurement taking after the test.

Digital Image Correlation (DIC) is the natural extension of video extensometry. 2D DIC takes measurements in the axial and transverse planes of a materials test specimen, and 3D DIC combines images from two video cameras to take 3D measurements.

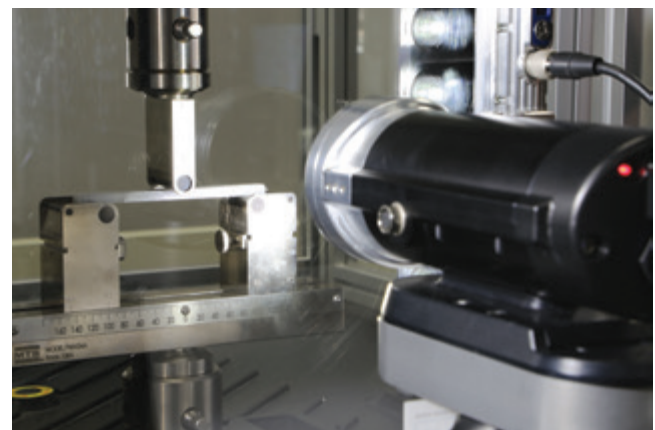

Video extensometer

The Right Extensometer For You

Choosing the correct extensometer becomes much easier when you remember S.T.R.A.I.N. Start with the specimen properties, then consider the test method, range, atmosphere, ISO/ASTM calibration, and non-contact requirements to select the best option for your application.

Axial Extensometers

Miniature Extensometers: <6 mm (<0.23 in) Gage Length

- » MTS Model 632.29 Extensometers are really small, because sometimes there just is not enough room. Most models are only 15.3 mm (0.60 in) tall and weigh roughly 6 g
- » Typical applications include testing of small wires, brittle or fragile materials, small organic specimens, or expensive materials
- » Includes a gage fixture for proper gage length setting and a 1000 Ohm fully-active Wheatstone bridge for high sensitivity
- » Meets or exceeds requirements for calibration according to ASTM E83 Class B1 and ISO 9513 Class 0.5 standards

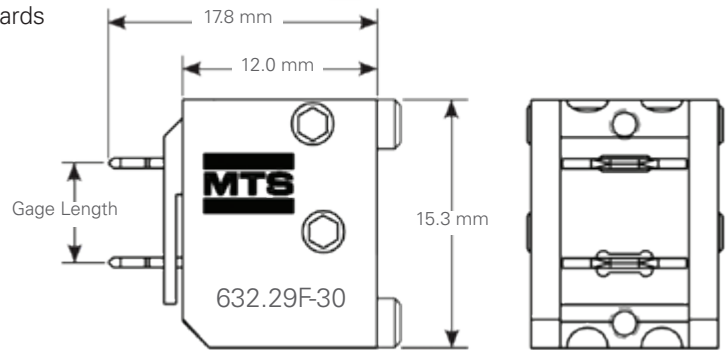

Metric Units

| MODEL | GAGE LENGTH | MEASURING RANGE (% STRAIN) | HEIGHT | LENGTH | TEMPERATURE RANGE MIN/MAX* | ACTIVATION FORCE | INCLUDES QUICK ATTACHMENT KIT FOR FLAT AND ROUND SPECIMENS | PART NUMBER |
|------------|-------------|----------------------------|---------|---------|----------------------------|------------------|--|-------------|
| 632.29F-20 | 3 mm | ±8% | 15.3 mm | 17.8 mm | -100°C / 150°C | 30 g | | 047-402-102 |
| 632.29F-30 | 5 mm | -10% / 30% | 15.3 mm | 36.8 mm | -100°C / 150°C | 30 g | x | 047-402-108 |
| 632.29F-30 | 6 mm | ±4% | 15.3 mm | 17.8 mm | -100°C / 150°C | 30 g | | 047-402-104 |

US Customary Units

| MODEL | GAGE LENGTH | MEASURING RANGE (% STRAIN) | HEIGHT | LENGTH | TEMPERATURE RANGE MIN/MAX* | ACTIVATION FORCE | INCLUDES QUICK ATTACHMENT KIT FOR FLAT AND ROUND SPECIMENS | PART NUMBER |
|------------|-------------|----------------------------|---------|---------|----------------------------|------------------|--|-------------|
| 632.29E-20 | 0.12 in | ±8% | 0.60 in | 0.70 in | -150°F / 300°F | 30 g | | 047-402-101 |

*These units may be used at 25°C (50°F) higher than the listed temperatures, but only for durations less than 24 hours.

Quick Attachment Kits

Improve your productivity by selecting the part number that includes a quick attachment kit. Includes adapters for flat and round specimens.



Axial Extensometers

Axial Extensometers with <25 mm (<1 in) Gage Length

- » Models 632.13 and 632.26 extensometers are ideal for testing small specimens
- » Measuring range is equally divided into tensile and compressive range
- » Includes knife edges and manual attachment fixtures for round specimens
- » Select the -21 or -31 model for cryogenic testing down to -269°C (-452°F)
- » Models include quick attachment kits for round and flat specimens where indicated. Additional quick attachment kits are available upon request
- » Meets or exceeds requirements for calibration according to ASTM E83 Class B1 and ISO 9513 Class 0.5 standards

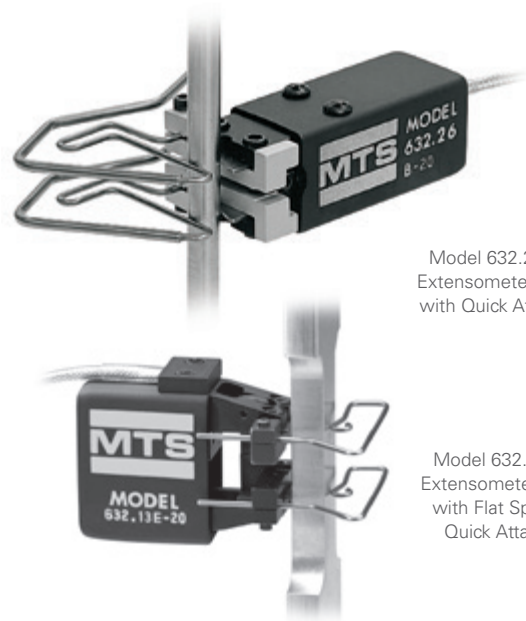

Model 632.26 Axial Extensometer (shown with Quick Attach Kit)

Model 632.13 Axial Extensometer (shown with Flat Specimen Quick Attach Kit)

Metric Units

| MODEL | GAGE LENGTH | MEASURING RANGE (% STRAIN) | HEIGHT | LENGTH | TEMPERATURE MIN/MAX* | ACTIVATION FORCE | INCLUDES QUICK ATTACHMENT KIT | PART NUMBER |
|------------|-------------|----------------------------|---------|---------|----------------------|------------------|-------------------------------|-------------|
| 632.26F-3x | 8 mm | ±6% | 17.5 mm | 44.5 mm | | | | |
| 632.26F-30 | | | | | -100°C / 150°C | 40 g | | 047-401-810 |
| 632.26F-30 | | | | | -100°C / 150°C | 40 g | x | 047-401-821 |
| 632.26F-31 | | | | | -269°C / 65°C | 40 g | | 047-401-811 |
| 632.26F-2x | 8 mm | ±15% | 17.5 mm | 44.5 mm | | | | |
| 632.26F-20 | | | | | -100°C / 150°C | 40 g | | 047-401-804 |
| 632.26F-20 | | | | | -100°C / 150°C | 40 g | x | 047-401-849 |
| 632.26F-23 | | | | | -100°C / 175°C | 60 g | | 047-401-806 |
| 632.13F-2x | 10 mm | ±15% | 32.8 mm | 41.1 mm | | | | |
| 632.13F-20 | | | | | -100°C / 150°C | 45 g | | 047-401-004 |
| 632.13F-20 | | | | | -100°C / 150°C | 45 g | x | 047-401-010 |
| 632.13F-21 | | | | | -269°C / 65°C | 45 g | | 047-401-005 |
| 632.13F-23 | | | | | -100°C / 175°C | 65 g | | 047-401-006 |
| 632.26F-4x | 12 mm | ±9% | 18.8 mm | 44.5 mm | | | | |
| 632.26F-40 | | | | | -100°C / 150°C | 40 g | | 047-401-816 |
| 632.26F-40 | | | | | -100°C / 150°C | 40 g | x | 047-401-822 |

US Customary Units

| MODEL | GAGE LENGTH | MEASURING RANGE (% STRAIN) | HEIGHT | LENGTH | TEMPERATURE MIN/MAX* | ACTIVATION FORCE | INCLUDES QUICK ATTACHMENT KIT | PART NUMBER |
|------------|-------------|----------------------------|---------|----------|----------------------|------------------|-------------------------------|-------------|
| 632.26E-3x | 0.300 in | ±6% | 0.69 in | 0.175 in | | | | |
| 632.26E-30 | | | | | -150°F / 300°F | 40 g | | 047-401-807 |
| 632.26E-2x | 0.300 in | ±15% | 0.69 in | 0.175 in | | | | |
| 632.26E-20 | | | | | -150°F / 300°F | 40 g | | 047-401-801 |
| 632.13E-2x | 0.500 in | ±15% | 1.29 in | 1.62 in | | | | |
| 632.13E-20 | | | | | -150°F / 300°F | 45 g | | 047-401-001 |
| 632.13E-20 | | | | | -150°F / 300°F | 45 g | x | 047-401-007 |
| 632.13E-21 | | | | | -452°F / 150°F | 45 g | | 047-401-002 |
| 632.26E-4x | 0.500 in | ±9% | 0.74 in | 1.75 in | | | | |
| 632.26E-40 | | | | | -150°F / 300°F | 40 g | | 047-401-813 |
| 632.26E-41 | | | | | -452°F / 150°F | 40 g | | 047-401-814 |
| 632.26E-43 | | | | | -150°F / 350°F | 60 g | | 047-401-815 |

*These units may be used at 25°C (50°F) higher than the listed temperatures, but only for durations less than 24 hours.

Axial Extensometers

Axial Extensometers with 25 mm (1 in) Gage Length

- » Ideal for a variety of applications including metals, plastics, rubbers, and composites
- » Low activation force without slipping on your specimen
- » High natural frequency and sensitivity make them useful in determining properties during failure
- » Select the -21 model for cryogenic testing down to -269°C (-452°F)
- » All part numbers include knife edges, quick attachment fixtures for flat and round specimens, and standard elastic attachment kit
- » Meets or exceeds requirements for calibration according to ASTM E83 Class B1 and ISO 9513 Class 0.5 standards

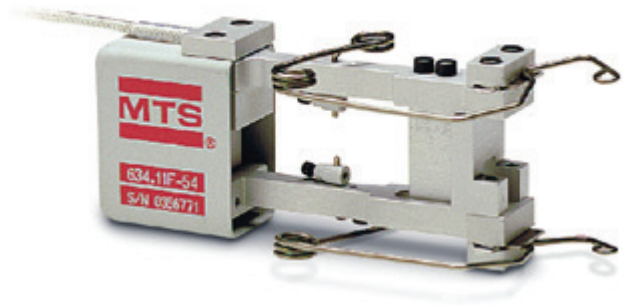

Metric Units

| MODEL | GAGE LENGTH | MEASURING RANGE (% STRAIN) | HEIGHT | LENGTH | TEMPERATURE MIN/MAX | ACTIVATION FORCE | INCLUDES QUICK ATTACHMENT KIT | PART NUMBER |
|------------|-------------|----------------------------|---------|---------|---------------------|------------------|-------------------------------|-------------|
| 634.11F-2x | 25 mm | +20% / -10% | 33.0 mm | 73.4 mm | | | | |
| 634.11F-21 | | | | | -269°C / 65°C* | 35 g | x | 052-251-807 |
| 634.11F-24 | | | | | -85°C / 120°C* | 35 g | x | 052-251-808 |
| 634.11F-25 | | | | | -100°C / 175°C | 45 g | x | 052-251-809 |
| 634.11F-5x | 25 mm | +20% | 33.0 mm | 73.4 mm | | | | |
| 634.11F-54 | | | | | -85°C / 120°C* | 35 g | x | 052-251-811 |
| 634.11F-55 | | | | | -100°C / 175°C | 45 g | x | 052-251-812 |
| 634.12F-2x | 25 mm | +50% / -10% | 33.0 mm | 82.8 mm | | | | |
| 634.12F-21 | | | | | -269°C / 65°C* | 45 g | x | 051-191-507 |
| 634.12F-24 | | | | | -85°C / 120°C* | 45 g | x | 051-191-508 |
| 634.12F-25 | | | | | -100°C / 175°C | 55 g | x | 051-191-509 |
| 634.12F-5x | 25 mm | +50% | 33.0 mm | 82.8 mm | | | | |
| 634.12F-51 | | | | | -269°C / 65°C* | 45 g | x | 051-191-510 |
| 634.12F-54 | | | | | -85°C / 120°C* | 45 g | x | 051-191-511 |
| 634.12F-55 | | | | | -100°C / 175°C | 55 g | x | 051-191-512 |

US Customary Units

| MODEL | GAGE LENGTH | MEASURING RANGE (% STRAIN) | HEIGHT | LENGTH | TEMPERATURE MIN/MAX | ACTIVATION FORCE | INCLUDES QUICK ATTACHMENT KIT | PART NUMBER |
|------------|-------------|----------------------------|---------|---------|---------------------|------------------|-------------------------------|-------------|
| 634.11E-2X | 1.00 in | +20% / -10% | 1.30 in | 2.89in | | | | |
| 634.11E-21 | | | | | -452°F / 150°F* | 35 g | x | 052-251-801 |
| 634.11E-24 | | | | | -120°F / 250°F* | 35 g | x | 052-251-802 |
| 634.11E-25 | | | | | -150°F / 350°F | 45 g | x | 052-251-803 |
| 634.11E-5X | 1.00 in | +20% | 1.30 in | 2.82 in | | | | |
| 634.11E-54 | | | | | -120°F / 250°F * | 35 g | x | 052-251-805 |
| 634.11E-55 | | | | | -150°F / 350°F | 45 g | x | 052-251-806 |
| 634.12E-2X | 1.00 in | +50% / -10% | 1.30 in | 3.26 in | | | | |
| 634.12E-21 | | | | | -452°F / 150°F* | 45 g | x | 051-191-501 |
| 634.12E-24 | | | | | -120°F / 250°F* | 45 g | x | 051-191-502 |
| 634.12E-25 | | | | | -150°F / 350°F | 55 g | x | 051-191-503 |
| 634.12E-5X | 1.00 in | +50% | 1.30 in | 3.26 in | | | | |
| 634.12E-54 | | | | | -120°F / 250°F* | 45 g | x | 051-191-505 |

*These units may be used at 25°C (50°F) higher than the listed temperatures, but only for durations less than 24 hours. See the MTS Fundamental Series 635 Extensometers on page 19 for an affordable monotonic only option.

Axial Extensometers

Low Strain, High Frequency Axial Extensometers with 25 mm (1 in) Gage Lengths

- » Small measuring ranges make Model 632.27 extensometers highly sensitive to detecting small displacement changes in ceramics and ceramic matrix composites
- » Extremely short arms and high natural frequencies ensure that this extensometer measures accurate strains at up to 150 Hz
- » Meets or exceeds requirements for calibration according to ASTM E83 Class B1 and ISO 9513 Class 0.5 standards

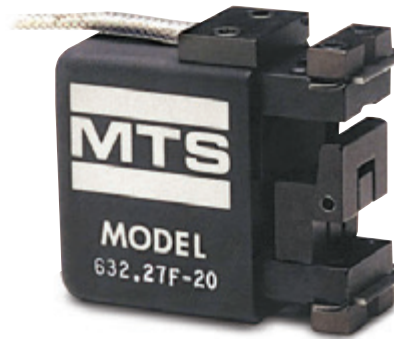

Metric Units

| MODEL | GAGE LENGTH | MEASURING RANGE (% STRAIN) | HEIGHT | LENGTH | TEMPERATURE RANGE MIN/MAX* | ACTIVATION FORCE | INCLUDES QUICK ATTACHMENT KIT FOR FLAT AND ROUND SPECIMENS | PART NUMBER |
|------------|-------------|----------------------------|---------|---------|----------------------------|------------------|--|-------------|
| 632.27F-2x | 25 mm | ±4% | 33.0 mm | 44.1 mm | | | | |
| 632.27F-20 | | | | | -100°C / 150°C | 60 g | | 047-401-904 |
| 632.27F-21 | | | | | -269°C / 65 °C | 60 g | | 047-401-905 |
| 632.27F-23 | | | | | -100°C / 175°C | 90 g | | 047-401-906 |
| 632.27F-3x | 25 mm | ±2% | 33.0 mm | 44.1 mm | | | | |
| 632.27F-30 | | | | | -100°C / 150°C | 60 g | | 047-402-004 |

US Customary Units

| MODEL | GAGE LENGTH | MEASURING RANGE (% STRAIN) | HEIGHT | LENGTH | TEMPERATURE RANGE MIN/MAX* | ACTIVATION FORCE | INCLUDES QUICK ATTACHMENT KIT FOR FLAT AND ROUND SPECIMENS | PART NUMBER |
|------------|-------------|----------------------------|---------|---------|----------------------------|------------------|--|-------------|
| 632.27E-2x | 1 in | ±4% | 1.30 in | 1.62 in | | | | |
| 632.27E-20 | | | | | -150°F / 350°F | 60 g | | 047-401-901 |
| 632.27E-3x | 1 in | ±2% | 1.30 in | 1.62 in | | | | |
| 632.27E-30 | | | | | -150°F / 350°F | 60 g | | 047-402-001 |

*These units may be used at 25°C (50 °F) higher than the listed temperatures, but only for durations less than 24 hours.

Testing at High Temperatures?

MTS offers a full range of high temperature extensometers that work with our chambers and furnaces.

See pages 24-26 for details.



Axial Extensometers

Axial Extensometers with 50 mm (2 in) Gage Length

- » Ideally suited for tensile testing of plastics, rubber, and elastomers
- » Long travel and mechanical stops enable you to leave it on the specimen through failure without damaging the unit
- » Activation forces as low as 30 g prevent specimen damage without slipping
- » Select the -21 or -51 model for cryogenic testing down to -269°C (-452°F)
- » All part numbers include hardened knife edges, quick attachment fixtures for flat and round specimens, and standard elastic attachment kits
- » Meets or exceeds requirements for calibration according to ASTM E83 Class B1 and ISO 9513 Class 0.5 standards



Metric Units

| MODEL | GAGE LENGTH | MEASURING RANGE (% STRAIN) | HEIGHT | LENGTH | TEMPERATURE RANGE MIN/MAX | ACTIVATION FORCE | INCLUDES QUICK ATTACHMENT KIT FOR FLAT AND ROUND SPECIMENS | PART NUMBER |
|------------|-------------|----------------------------|---------|----------|---------------------------|------------------|--|-------------|
| 634.25F-2x | 50 mm | +50% / -10% | 58.4 mm | 151.4 mm | | | | |
| 634.25F-21 | | | | | -269°C / 65°C* | 30 g | x | 051-191-607 |
| 634.25F-24 | | | | | -85°C / 120°C* | 30 g | x | 051-191-608 |
| 634.25F-25 | | | | | -100°C / 175°C | 45 g | x | 051-191-609 |
| 634.25F-5x | 50 mm | +50% | 58.4 mm | 151.4 mm | | | | |
| 634.25F-51 | | | | | -269°C / 65°C* | 30 g | x | 051-191-610 |
| 634.25F-54 | | | | | -85°C / 120°C* | 30 g | x | 051-191-611 |
| 634.25F-55 | | | | | -100°C / 175°C | 45 g | x | 051-191-612 |

See the MTS Fundamental Series 635 Extensometers on page 19 for an affordable monotonic only option.

US Customary Units

| MODEL | GAGE LENGTH | MEASURING RANGE (% STRAIN) | HEIGHT | LENGTH | TEMPERATURE RANGE MIN/MAX | ACTIVATION FORCE | INCLUDES QUICK ATTACHMENT KIT FOR FLAT AND ROUND SPECIMENS | PART NUMBER |
|------------|-------------|----------------------------|--------|---------|---------------------------|------------------|--|-------------|
| 634.25E-2x | 2.00 in | +50% / -10% | 2.3 in | 5.96 in | | | | |
| 634.25E-21 | | | | | -452°F / 150°F* | 30 g | x | 051-191-601 |
| 634.25E-24 | | | | | -120°F / 250°F* | 30 g | x | 051-191-602 |
| 634.25E-25 | | | | | -150°F / 350°F | 45 g | x | 051-191-603 |
| 634.25E-5x | 2.00 in | +50% | 2.3 in | 5.96 in | | | | |
| 634.25E-51 | | | | | -452°F / 150°F* | 30 g | x | 051-191-604 |
| 634.25E-54 | | | | | -120°F / 250°F* | 30 g | x | 051-191-605 |
| 634.25E-55 | | | | | -150°F / 350°F | 45 g | x | 051-191-606 |

*These units may be used at 25°C (50°F) higher than the listed temperatures, but only for durations less than 24 hours.
See the MTS Fundamental Series 635 Extensometers on page 19 for an affordable monotonic only option.

Axial Extensometers

Enhanced Travel Axial Extensometers

- » Designed for plastics, rubber, and elastomer testing, these extensometers can measure up to 100% strain
- » Utilizes a zero-stop for setting the initial gage length and simplifying mounting. Simply hold the arms together and attach the extensometer to the specimen
- » All part numbers include our quick attachment fixtures



Model 632.24

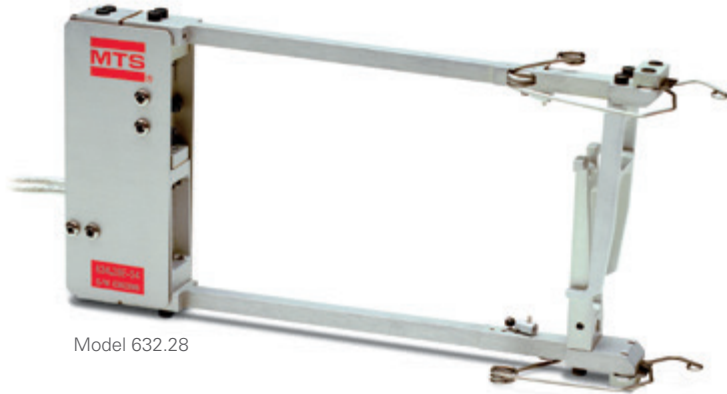

Model 632.28

Metric Units

| MODEL | GAGE LENGTH | MEASURING RANGE (% STRAIN) | HEIGHT | LENGTH | TEMPERATURE RANGE MIN/MAX* | ACTIVATION FORCE | INCLUDES QUICK ATTACHMENT KIT FOR FLAT AND ROUND SPECIMENS | PART NUMBER |
|------------|-------------|----------------------------|---------|----------|----------------------------|------------------|--|-------------|
| 632.24F-5x | 25 mm | +100% | 33 mm | 123.2 mm | | | | |
| 632.24F-50 | | | | | -100°C /150°C | 30 g | x | 047-401-602 |
| 634.28F-2x | 50 mm | +100% | 73.7 mm | 155.6 mm | | | | |
| 634.28F-24 | | | | | -85°C /120°C | 55 g | x | 056-355-802 |

US Customary Units

| MODEL | GAGE LENGTH | MEASURING RANGE (% STRAIN) | HEIGHT | LENGTH | TEMPERATURE RANGE MIN/MAX* | ACTIVATION FORCE | INCLUDES QUICK ATTACHMENT KIT FOR FLAT AND ROUND SPECIMENS | PART NUMBER |
|------------|-------------|----------------------------|--------|---------|----------------------------|------------------|--|-------------|
| 632.24E-5x | 1 in | +100% | 1.3 in | 4.85 in | | | | |
| 632.24E-50 | | | | | -150°F / 300°F | 30 g | x | 047-401-601 |
| 634.28E-2x | 2 in | +100% | 2.9 in | 6.13 in | | | | |
| 634.24E-24 | | | | | -120°F / 250°F | 55 g | x | 056-355-801 |

*These units may be used at 25°C (50°F) higher than the listed temperatures, but only for durations less than 24 hours.

Axial Extensometers

Axial Extensometers with Multiple Gage Lengths

- » Measure and control strain on a variety of different specimen types using this configurable extensometer
- » Features multiple gage lengths to provide flexibility to run a variety of tests without recalibration
 - 9 gage lengths available between 10 mm and 50 mm in the metric models
 - 6 gage lengths available in the US customary models
- » Easy gage length changeover reduces set-up time between tests
- » Quick attachment fixtures are included and can accommodate:
 - Round specimens with diameters from 2.5 to 14.0 mm (0.10 to 0.56 in)
 - Flat specimens ranging in thickness from 10.5 to 26.0 mm (0.42 to 1.02 in)
- » Meets or exceeds requirements for calibration according to ASTM E83 Class B2 and ISO 9513 Class 0.5 standards

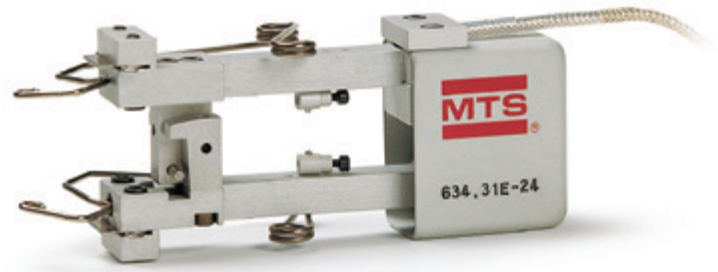

| Metric Units | |
|-----------------------|---|
| Available Gage Length | Measuring Range (% Strain, rounded to nearest 1%) |
| 10 mm | +40% / -20% |
| 15 mm | +27% / -13% |
| 20 mm | +20% / -10% |
| 25 mm | +16% / -8% |
| 30 mm | +13% / -7% |
| 35 mm | +11% / -6% |
| 40 mm | +10% / -5% |
| 45 mm | +9% / -4% |
| 50 mm | +8% / -4% |

| US Customary Units | |
|-----------------------|---|
| Available Gage Length | Measuring Range (% Strain, rounded to nearest 1%) |
| 0.500 in | +40% / -20% |
| 0.750 in | +27% / -13% |
| 1.000 in | +20% / -10% |
| 1.500 in | +13% / -4% |
| 1.750 in | +11% / -6% |
| 2.000 in | +10% / -5% |

Metric Units

| MODEL | GAGE LENGTH | MEASURING RANGE (% STRAIN) | HEIGHT (MIN/MAX) | LENGTH | TEMPERATURE RANGE MIN/MAX | ACTIVATION FORCE | INCLUDES QUICK ATTACHMENT KIT FOR FLAT AND ROUND SPECIMENS | PART NUMBER |
|------------|-------------|----------------------------|-------------------|---------|---------------------------|------------------|--|-------------|
| 634.31F-2x | See above | | 32.5 mm / 59.4 mm | 73.8 mm | | | | |
| 634.31F-21 | | | | | -269°C / 65°C* | 32 g | x | 052-251-904 |
| 634.31F-24 | | | | | -85°C / 120°C* | 32 g | x | 052-251-905 |
| 634.31F-25 | | | | | -100°C / 175°C | 40 g | x | 052-251-906 |

Each 634.31F-2x extensometer includes components to set it to the nine gage lengths listed. The extensometer weighs between 36 and 42 g, depending on the mass of the components in use.

US Customary Units

| MODEL | GAGE LENGTH | MEASURING RANGE (% STRAIN) | HEIGHT (MIN/MAX) | LENGTH | TEMPERATURE RANGE MIN/MAX | ACTIVATION FORCE | INCLUDES QUICK ATTACHMENT KIT FOR FLAT AND ROUND SPECIMENS | PART NUMBER |
|------------|-------------|----------------------------|-------------------|--------|---------------------------|------------------|--|-------------|
| 634.31E-2x | See above | | 1.28 in / 2.34 in | 2.9 in | | | | |
| 634.31E-21 | | | | | -452°F / 150°F* | 40 g | x | 052-251-901 |
| 634.31E-24 | | | | | -120°F / 250°F* | 40 g | x | 052-251-902 |
| 634.31E-25 | | | | | -150°F / 350°F | 50 g | x | 052-251-903 |

Each 634.31E-2x extensometer includes components to set it to the nine gage lengths listed. The extensometer weighs between 36 and 42 g, depending on the mass of the components in use.

Accessories for Axial Extensometers

Gage Length Extenders

Expand the Range of Use of Your Existing Extensometer

- » Gage length extender kits modify the gage length of existing extensometers to perform strain measurements on specimens which have non-standard gage lengths
- » Travel of the extensometers is not affected by the addition of extenders, but the strain measuring range will be reduced
- » Each extender/extensometer combination requires separate calibration

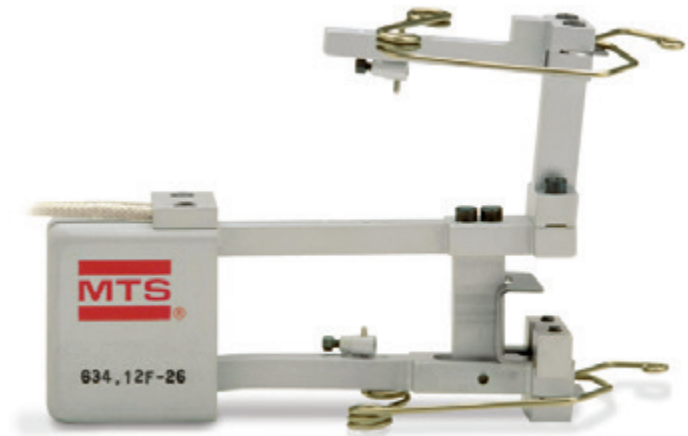

Metric Units

| EXTENDER MODEL | GAGE LENGTH WITH EXTENDER | EXTENSOMETER MODELS (TYPE) | PART NUMBER |
|----------------|---|---|-------------|
| 634.15C-30 | 50 mm | 634.11/12 (F) | 051-191-901 |
| 634.15C-31 | 100 mm | 634.11/12 (F) | 051-191-902 |
| 634.15C-32 | 150 mm | 634.11/12 (F) | 051-191-903 |
| 634.15C-33 | 200 mm | 634.11/12 (F) | 051-191-904 |
| 634.15C-37 | Kit of 50, 100, 150, & 200 mm extenders | Kit of 50, 100, 150, & 200 mm extenders | 051-191-905 |
| 634.15C-40 | 100 mm | 634.25 (F) | 051-191-908 |
| 634.15C-41 | 150 mm | 634.25 (F) | 051-191-909 |
| 634.15C-42 | 200 mm | 634.25 (F) | 051-191-910 |
| 634.15C-47 | Kit of 100, 150, & 200 mm extenders | Kit of 100, 150, & 200 mm extenders | 051-191-911 |

US Customary Units

| EXTENDER MODEL | GAGE LENGTH WITH EXTENDER | EXTENSOMETER MODELS (TYPE) | PART NUMBER |
|----------------|----------------------------------|----------------------------------|-------------|
| 634.15B-30 | 2 in | 634.11/12 (E) | 051-191-801 |
| 634.15B-31 | 4 in | 634.11/12 (E) | 051-191-802 |
| 634.15B-32 | 6 in | 634.11/12 (E) | 051-191-803 |
| 634.15B-33 | 8 in | 634.11/12 (E) | 051-191-804 |
| 634.15B-37 | Kit of 2, 4, 6, & 8 in extenders | Kit of 2, 4, 6, & 8 in extenders | 051-191-805 |
| 634.15B-40 | 4 in | 634.25 (E) | 051-191-808 |
| 634.15B-41 | 6 in | 634.25 (E) | 051-191-809 |
| 634.15B-42 | 8 in | 634.25 (E) | 051-191-810 |
| 634.15B-47 | Kit of 4,6, & 8 in extenders | Kit of 4,6, & 8 in extenders | 051-191-811 |

Extenders for additional models and gage lengths available upon request.

Quick Attachment Kits & Replacement Parts

- » Improve your productivity by buying a Quick Attachment Kit for your extensometer
- » Includes adapters for flat and round specimens

| DESCRIPTION | PART NUMBER |
|--|-------------|
| Quick Attach Spring Set (includes 2 springs) | |
| For all 634.xx models except 634.31F | 047-201-911 |
| For Model 634.31F | 047-201-920 |
| Spring Retainer (holds 1 spring in place) | 055-467-601 |

Extenders for additional models and gage lengths available upon request.

Accessories for Axial Extensometers

Specimen Attachment Kits

Large Diameter Specimen Attachment Kit

- » Recommended for specimens larger than 32 mm (1.25 in) in diameter
- » Provides a more effective attachment angle and increases the normal force pressing the extensometer onto the specimen
- » Increases stability of the extensometer on the specimen
- » Includes two remote spring attachment bracket assemblies that mount on the extensometer arms and an assortment of 16 tension springs
- » For use with models 632.11/.12/.25 and 634.11/.12/.25



Replacement Knife Edges for Extensometers

- » Replacements for those provided with extensometers
- » Stainless steel with a Rockwell hardness of Rc 58 to 60
- » Round specimen knife edges have a 90° included angle
- » Flat specimen knife edges provide three point specimen contact by means of one single point and one double point contact knife edge

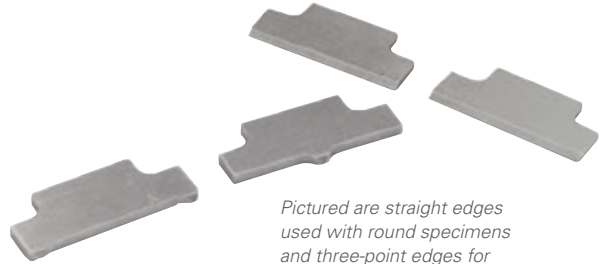

Flat Specimen Attachment Kit – Wire Form Method

- » Mounts a heavy duty, remote spring bracket assembly to the arms of the extensometer
- » Formed wire reacts with the force of the springs directly across from the knife edges

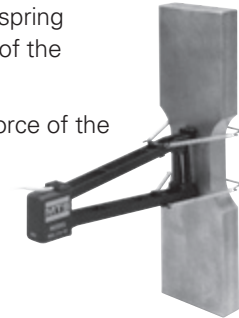

Flat Specimen Attachment Kit – Disc Method

- » Primarily used for specimens less than 12 mm (0.5 in) in width
- » Effectively makes specimen appear as a round specimen for extensometer mounting purposes



| DESCRIPTION | 634.XX PART NUMBER | 632.XX PART NUMBER |
|--|-----------------------|-----------------------|
| Large Diameter Kit for 63x.11/.12/.25 | 053-063-001 | 038-863-801 |
| Flat Specimen Attachment Kit – Disc Method | 100-020-108 | 034-505-201 |
| Flat Specimen Attachment Kit – Wire Form Method, for specimens up to 25 mm (1 in) wide | 100-058-679 | |

Extenders for additional models and gage lengths available upon request.

MTS Fundamental Series 635 Extensometers

Monotonic Extensometers for Tensile Testing

- » Series 635 extensometers are specially designed for popular monotonic axial tensile strain measurement. They are an economic choice, ideal for large volume QA/QC testing.
- » Features proprietary strain gaged elements made from special heat-treated alloy
- » Ground profile, dual-member flexure provides for very low activation force with excellent strength
- » True center-point bending resulting in low hysteresis and exceptionally accurate strain readings
- » Mechanical stops can be attached through specimen failure without damaging the unit
- » Zero-set pin enables accurate and consistent determination of the initial gage length
- » Not intended for immersion in water or other liquids
- » Hardened, replaceable knife edges for flat and round specimens are included
- » Patented MTS quick-attach springs for fast and easy specimen attachment are included
- » Standard 1.5 m (60 in) cable is included
- » Typical Linearity¹ is 0.08% of range
- » Accuracy² designed to meet ASTM E83 Class B1 and ISO 9513 Class 0.5 standards
- » Temperature Range is 4°C to 50°C (40°F to 120°F)
- » **Applications:** Axial tensile strain measurements for large volume QA/QC testing



Axial Extensometers for Monotonic Testing Only, MTS Fundamental Series 635

| MODEL | GAGE LENGTH | MAXIMUM TRAVEL | MAXIMUM STRAIN | LENGTH (FROM KNIFE EDGE TO BACK OF HOUSING) | HEIGHT (FROM BOTTOM TO TOP) | PART NUMBER |
|-------------|-------------|----------------|----------------|---|-----------------------------|-------------|
| 635.25F-05 | 25 mm | +5 mm | 20% | 77.5 mm (3.1 in) | 39.6 mm (1.1 in) | 057-863-506 |
| 635.50F-05 | 50 mm | +5 mm | 10% | 77.5 mm (3.1 in) | 59.2 mm (2.3 in) | 057-863-505 |
| 635.50F-10 | 50 mm | +10 mm | 20% | 77.5 mm (3.1 in) | 61.5 mm (2.4 in) | 057-863-504 |
| 635.50F-25 | 50 mm | +25 mm | 50% | 153.7 mm (6.1 in) | 69.1 mm (2.7 in) | 057-863-503 |
| 635.100F-10 | 100 mm | +10 mm | 10% | 77.5 mm (3.1 in) | 111.8 mm (4.4 in) | 057-863-502 |
| 635.100F-25 | 100 mm | +25 mm | 25% | 153.7 mm (6.1 in) | 119.1 mm (4.7 in) | 057-863-501 |

Notes:

- 1 Linearity stated is for ascending data and is the deviation from best fit straight line thru zero expressed as a percent of full scale.
- 2 Calibrations are separate. These extensometers leave the factory with a quality validation and verification by sampling three measurement points to validate performance. The 635 series extensometers are intended to meet ASTM class B-1 and ISO class 0.5.

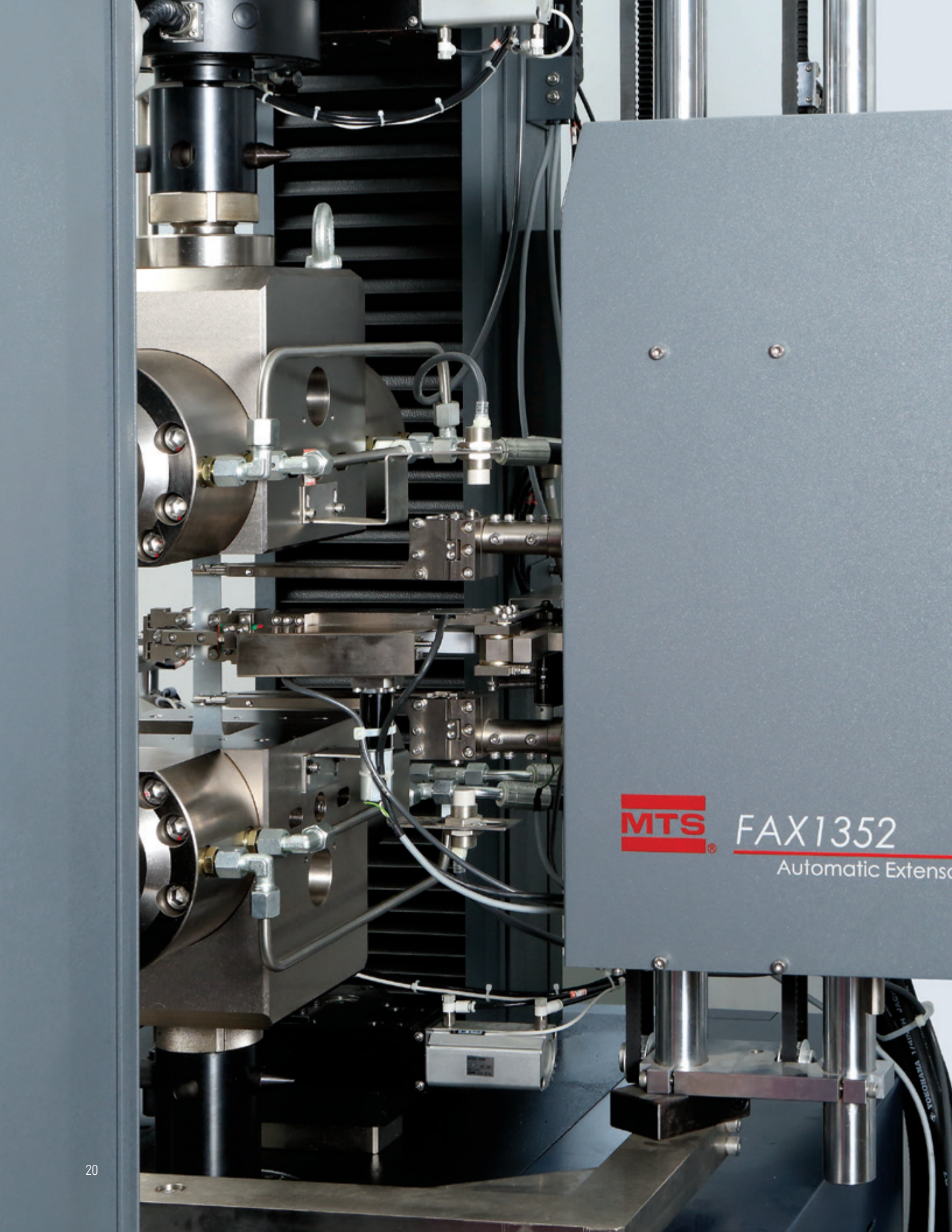

MTS

FAX1352

Automatic Extensometer

Fundamental™ Automatic Extensometer (FAX)

Automatic Extensometer for Criterion® and Exceed® Universal Test Systems

- » FAX1352 automatic extensometer is compatible with MTS Criterion and Exceed Universal Test Systems
- » Designed for longevity
- » Optimized for high-volume testing of single gage length specimens
- » Rotational Mount allows the operator to quickly rotate the FAX out of the test area for easy access to the specimen
- » Ideal for axial strain measurement for tensile testing on Universal Test Systems



Axial Model Specifications

| MODEL | ARM LENGTH | GAGE LENGTH* | RELATIVE ERROR | MEASURING RANGE | AXIAL RESOLUTION | THICKNESS OR DIAMETER RANGE |
|---------|------------|---------------------------|----------------|-----------------------|------------------|---|
| FAX1352 | 350 mm | 10-200 mm (0.4-7.9 in) | ±1% | 0-80 mm (0-3.1 in) | ≤0.2 μm | Flat: 0.2-40 mm (0.0008-1.57 in) Round: 0.2-40 mm (0.0008-1.57 in) |

* Recalibration is required whenever the specimen gage length is changed.

Advantage™ High Elongation Extensometer (AHX850)

High Elongation Extensometer for Criterion® Universal Test Systems

- » Accurately measure strain in specimens prone to large displacement
- » Displacement up to 850 mm (33.5 in)
- » Six preset gage lengths: 10 mm (0.4 in), 20 mm (0.8 in), 25 mm (1.0 in), 50 mm (2.0 in), 75 mm (2.95 in), 100 mm (3.9 in)
- » High resolution optical digital encoder eliminates noise, signal drift, and output changes
- » Balanced design with optimized arm and head weights
- » Swings away from test area when not in use
- » Optional fixed or rotational mount
- » Compatible with MTS Criterion® Universal Test Systems
- » Meets or exceeds requirements for calibration according to ASTM E83 Class B1 and ISO 9513 Class 0.5 standards
- » The gripping force is applied using adjustable springs

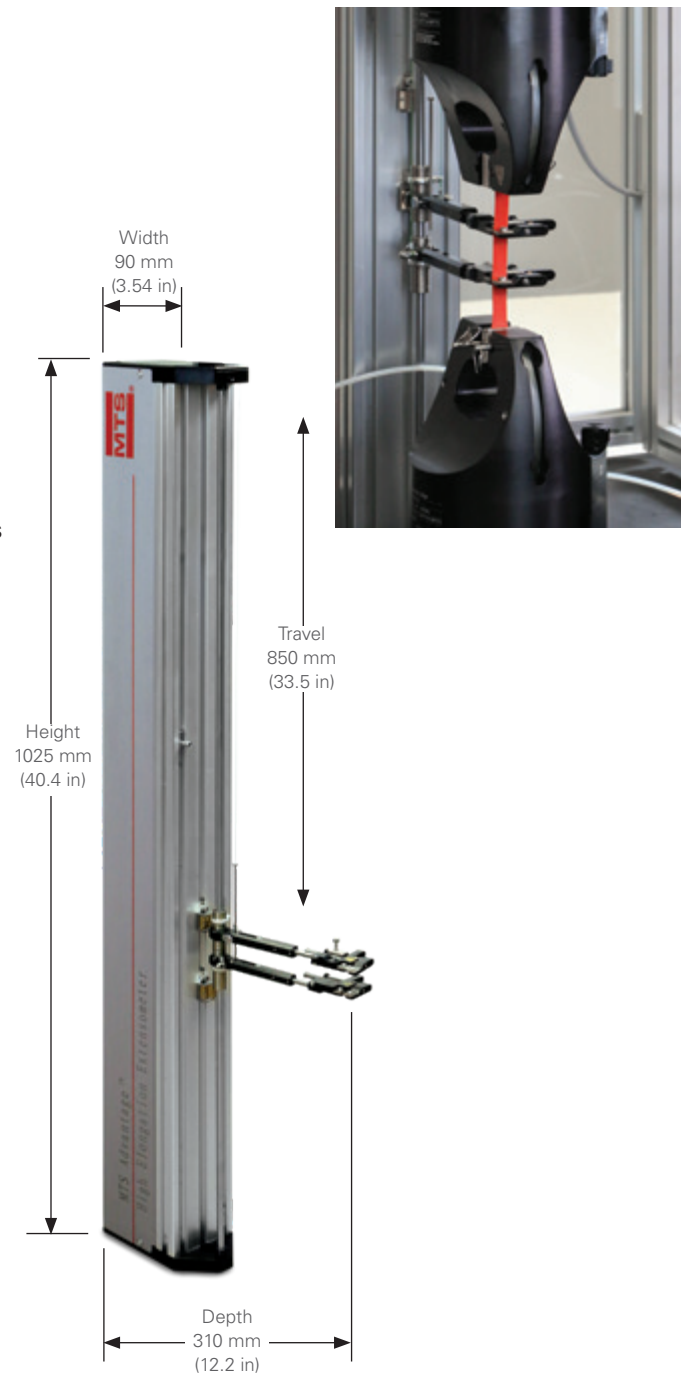

| MODEL | STANDARD GAGE LENGTH | MEASURING RANGE | HEIGHT | DEPTH | WEIGHT | TEMPERATURE RANGE | RESOLUTION | ARM OPENING | PART NUMBER |
|--------|---------------------------------------|----------------------------------|----------------------|---------------------|--------------------|--------------------------------|-------------------------|--------------------|-------------|
| AHX850 | 10 mm to 100 mm (0.4 in to 3.9 in) | 10 to 850 mm (0.4 to 33.4 in) | 1025 mm (40.4 in) | 310 mm (12.2 in) | 6 kg (13.2 lbs) | 5°C to 50°C (41°F to 122°F) | 0.006 mm (0.0002 in) | 30 mm (1.18 in) | 100-512-885 |

Long Travel Extensometer (LTX850)

High Elongation Extensometer for Exceed® Universal Test Systems

- » Used to measure displacement of materials, such as polymers and elastomers, which exhibit high elongation while in tension
- » Durable high strength aluminum structure
- » Dual independent digital input channels for upper and lower arms ensure accurate and reliable measurement
- » Changeable knife edges, adjustable gripping forces, and balanced head and arm weight allow smooth following of material strain change with minimal stickiness
- » Five preset gage lengths: 10 mm (0.4 in), 20 mm (0.8 in), 25 mm (1.0 in), 50 mm (2.0 in), 75 mm (2.95 in)
- » Choose fixed or rotational mounts
- » Compatible with Exceed® Universal Test Systems
- » Meets or exceeds requirements for calibration according to ASTM E83 Class B1 and ISO 9513 Class 0.5 standards
- » The gripping force is applied using adjustable springs

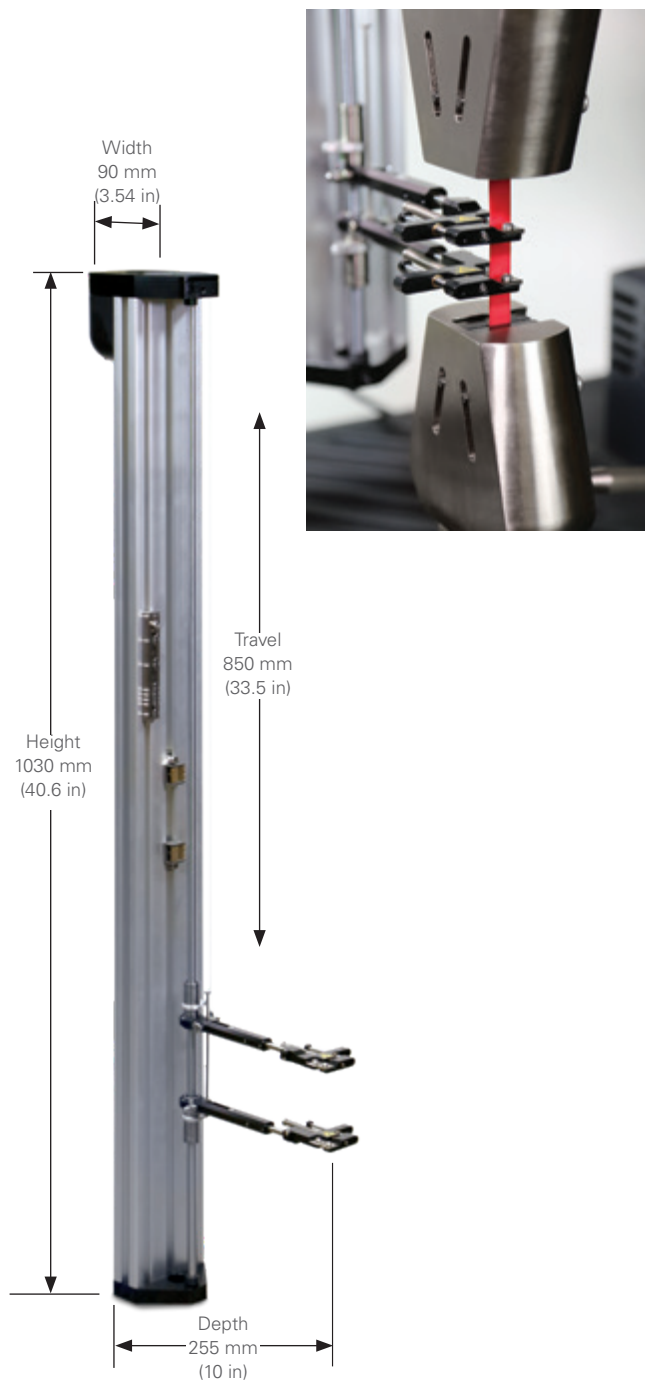

| MODEL | STANDARD GAGE LENGTH | MEASURING RANGE | HEIGHT | DEPTH | WEIGHT | TEMPERATURE RANGE | ALLOWED SPECIMEN SIZE | PART NUMBER |
|--------|---------------------------------------|----------------------------------|----------------------|-------------------|---------------------|--------------------------------|--|-------------|
| LTX850 | 10 mm to 75 mm (0.4 in to 2.95 in) | 10 to 850 mm (0.4 to 33.4 in) | 1030 mm (40.6 in) | 255 mm (10 in) | 5.3 Kg (11.7 lb) | 5°C to 50°C (41°F to 122°F) | Width: 20 mm (0.8 in) Thickness: 30 mm (1.2 in) | 100-542-797 |

High Temperature Extensometers

Air Cooled High Temperature Extensometers

- » Designed for measuring axial strain in high temperature tension, compression, and through-zero fatigue testing applications up to 1200°C (2200°F)
- » Includes ceramic extension rods that extend into the furnace and minimize rod creep, thermal expansion errors, and conduction losses from the specimen
- » Contact force varies by model. Select from models with 100 g, 300 g, 400 g, or 780 g contact forces
- » Air cooling required
- » Additional models and rod geometries available upon request
- » Meets or exceeds requirements for calibration according to ASTM E83 Class B1 and ISO 9513 Class 0.5 standards

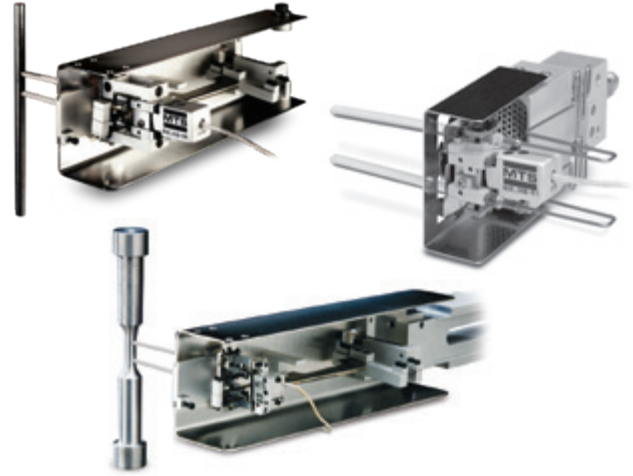

Metric Units

| MODEL | OPTION | GAGE LENGTH | MEASURING RANGE (% STRAIN) | MAXIMUM TEMPERATURE | CONTACT FORCE | CERAMIC EXTENSION RODS INCLUDED | PART NUMBER |
|------------|---------|-------------|----------------------------|---------------------|---------------|---|--------------------------|
| 632.50F-08 | 006,080 | 10 mm | +20%/-10% | 1200°C | 780 g | Qty 4, V-chisel Edge Rods, 3.50 mm (.138 in) rod diameter, 85 mm (3.35 in) long | 047-402-538 ¹ |
| 632.54F-11 | – | 12 mm | +20%/-10% | 1200°C | 100 g | Qty 4, V-chisel Edge Rods, 2.0 mm (.0787 in) rod diameter, 85 mm (3.35 in) long | 047-404-304 ¹ |
| 632.53F-14 | – | 12 mm | +20%/-10% | 1200°C | 260 g | Qty 4, V-chisel Edge Rods, 3.50 mm (.138 in) rod diameter, 85 mm (3.35 in) long | 047-404-104 ¹ |
| 632.53F-14 | – | 12 mm | +20%/-10% | 1200°C | 300 g | Qty 4, V-chisel Edge Rods, 3.50 mm (.138 in) rod diameter, 85 mm (3.35 in) long | 047-404-105 ¹ |
| 632.53F-14 | – | 12 mm | +20%/-10% | 1200°C | 400 g | Qty 4, V-chisel Edge Rods, 3.50 mm (.138 in) rod diameter, 85 mm (3.35 in) long | 047-404-106 ¹ |
| 632.50F-04 | 006,080 | 12 mm | +20%/-10% | 1200°C | 780 g | Qty 4, V-chisel Edge Rods, 3.50 mm (.138 in) rod diameter, 85 mm (3.35 in) long | 047-402-539 ¹ |
| 632.54F-11 | – | 25 mm | +10%/-5% | 1200°C | 100 g | Qty 4, V-chisel Edge Rods, 2.0 mm (.0787 in) rod diameter, 85 mm (3.35 in) long | 047-404-303 ¹ |
| 632.53F-11 | – | 25 mm | +20%/-10% | 1200°C | 260 g | Qty 2, V-chisel Edge Rods, 3.50 mm (.138 in) rod diameter, 85 mm (3.35 in) long | 047-404-110 ¹ |
| 632.53F-11 | – | 25 mm | +10%/-5% | 1200°C | 300 g | Qty 4, V-chisel Edge Rods, 3.50 mm (.138 in) rod diameter, 85 mm (3.35 in) long | 047-404-111 ¹ |
| 632.53F-11 | – | 25 mm | +10%/-5% | 1200°C | 400 g | Qty 4, V-chisel Edge Rods, 3.50 mm (.138 in) rod diameter, 85 mm (3.35 in) long | 047-404-112 ¹ |
| 632.50F-01 | 006,077 | 25 mm | +15%/-15% | 1200°C | 400 g | Qty 4, V-chisel Edge Rods, 3.50 mm (.138 in) rod diameter, 94 mm (3.7 in) long | 047-402-548 ¹ |

US Customary Units

| MODEL | OPTION | GAGE LENGTH | MEASURING RANGE (% STRAIN) | MAXIMUM TEMPERATURE | CONTACT FORCE | CERAMIC EXTENSION RODS INCLUDED | PART NUMBER |
|------------|---------|-------------|----------------------------|---------------------|---------------|---|--------------------------|
| 632.54E-14 | – | 0.50 in | +20%/-10% | 2200°F | 100 g | Qty 4, V-chisel Edge Rods, 2.0 mm (.0787 in) rod diameter, 85 mm (3.35 in) long | 047-404-302 ¹ |
| 632.53E-14 | – | 0.50 in | +20%/-10% | 2200°F | 260 g | Qty 4, V-chisel Edge Rods, 3.50 mm (.138 in) rod diameter, 85 mm (3.35 in) long | 047-404-101 ¹ |
| 632.53E-14 | – | 0.50 in | +20%/-10% | 2200°F | 300 g | Qty 4, V-chisel Edge Rods, 3.50 mm (.138 in) rod diameter, 85 mm (3.35 in) long | 047-404-102 ¹ |
| 632.53E-14 | – | 0.50 in | +20%/-10% | 2200°F | 400 g | Qty 4, V-chisel Edge Rods, 3.50 mm (.138 in) rod diameter, 85 mm (3.35 in) long | 047-402-103 ¹ |
| 632.50E-04 | 006,080 | 0.50 in | +20%/-10% | 2200°F | 780 g | Qty 4, V-chisel Edge Rods, 3.50 mm (.138 in) rod diameter, 85 mm (3.35 in) long | 047-402-525 ¹ |
| 632.54E-14 | – | 1.00 in | +10%/-5% | 2200°F | 100 g | Qty 4, V-chisel Edge Rods, 3.50 mm (.138 in) rod diameter, 85 mm (3.35 in) long | 047-402-301 ¹ |
| 632.53E-11 | – | 1.00 in | +10%/-5% | 2200°F | 260 g | Qty 4, V-chisel Edge Rods, 3.50 mm (.138 in) rod diameter, 85 mm (3.35 in) long | 047-404-107 ¹ |
| 632.53E-11 | – | 1.00 in | +10%/-5% | 2200°F | 300 g | Qty 4, V-chisel Edge Rods, 3.50 mm (.138 in) rod diameter, 85 mm (3.35 in) long | 047-404-108 ¹ |
| 632.53E-11 | – | 1.00 in | +10%/-5% | 2200°F | 400 g | Qty 4, V-chisel Edge Rods, 3.50 mm (.138 in) rod diameter, 85 mm (3.35 in) long | 047-404-109 ¹ |
| 632.50E-01 | 006,077 | 1.00 in | +15%/-15% | 2200°F | 400 g | Qty 4, V-chisel Edge Rods, 3.50 mm (.138 in) rod diameter, 94 mm (3.7 in) long | 047-402-547 ¹ |

¹ Mount is not required when using with 653.xx B furnace, for other installations contact MTS

High Temperature Extensometers

Water Cooled High Temperature Extensometers

- » Designed for measuring axial strain in high temperature tension, compression, and through-zero fatigue testing applications up to 1200°C (2200°F)
- » Water cooling is more effective at keeping the extensometer body at a constant temperature and reducing noise in the data measured
- » Includes ceramic extension rods that extend into the furnace and minimize rod creep, thermal expansion errors, and conduction losses from the specimen
- » Contact force varies by model. Select from models with 400 g or 780 g contact forces.
- » Water cooling required
- » Additional models and rod geometries available upon request
- » Meets or exceeds requirements for calibration according to ASTM E83 Class B1 and ISO 9513 Class 0.5 standards

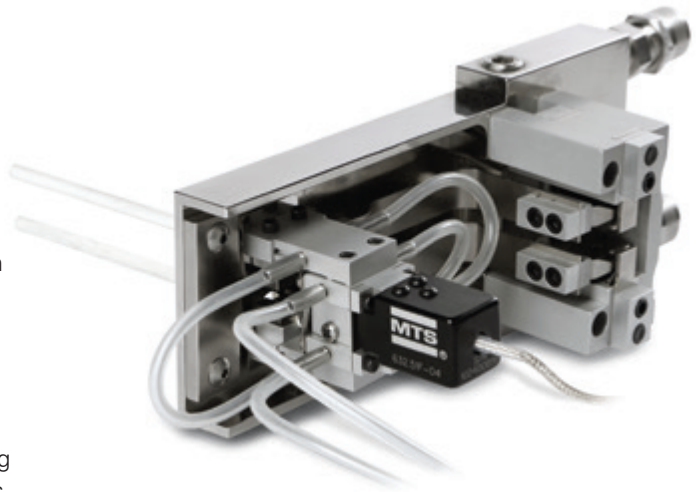

Metric Units

| MODEL | OPTION | GAGE LENGTH | MEASURING RANGE (% STRAIN) | MAXIMUM TEMPERATURE | CONTACT FORCE | CERAMIC EXTENSION RODS INCLUDED | PART NUMBER |
|------------|---------|-------------|----------------------------|---------------------|---------------|---|--------------------------|
| 632.51F-04 | 006,080 | 12 mm | +20% / -10% | 1200°C | 780 g | Qty 2, V-chisel Edge Rods, 3.50 mm (.138 in) rod diameter, 85 mm (3.35 in) long | 047-402-651 ¹ |
| 632.51F-01 | 006,077 | 25 mm | +15% / -10% | 1200°C | 400 g | Qty 2, V-chisel Edge Rods, 3.50 mm (.138 in) rod diameter, 94 mm (3.7 in) long | 047-402-652 ¹ |

US Customary Units

| MODEL | OPTION | GAGE LENGTH | MEASURING RANGE (% STRAIN) | MAXIMUM TEMPERATURE | CONTACT FORCE | CERAMIC EXTENSION RODS INCLUDED | PART NUMBER |
|------------|---------|-------------|----------------------------|---------------------|---------------|---|--------------------------|
| 632.51E-04 | 006,080 | 0.50 in | +20% / -10% | 2200°F | 780 g | Qty 2, V-chisel Edge Rods, 3.50 mm (.138 in) rod diameter, 85 mm (3.35 in) long | 047-402-650 ¹ |
| 632.51F-01 | 006,077 | 1.00 in | +15% / -10% | 1200°C | 400 g | Qty 2, V-chisel Edge Rods, 3.50 mm (.138 in) rod diameter, 94 mm (3.7 in) long | 047-402-653 ¹ |

¹ Mount is not required when using with 653.xx.B furnace, for other installations contact MTS.

High Temperature Extensometers

Elevated Temperature Axial Extensometer for Use in Chambers

- » Designed for measuring axial strain in elevated temperature testing environments without external cooling
- » Provides stable output, with low creep, for both tension and fatigue testing applications at temperatures from 40°C to 540°C (100° to 1000°F) and up to 85% relative humidity.
- » Fatigue rated up to 30 Hz
- » Compatible with controllers that use 494 or 493 series hardware. Not available for MTS electromechanical systems
- » Packed in a rugged storage case that contains the instrument, converter module, spare parts, springs, attachment devices, and tools



Metric Units

| MODEL | GAGE LENGTH | MEASURING RANGE (% STRAIN) | HEIGHT | LENGTH | TEMPERATURE RANGE MIN/MAX* | ACTIVATION FORCE | INCLUDES ATTACHMENT KIT |
|------------|-------------|----------------------------|---------|---------|----------------------------|------------------|-------------------------|
| 633.11M-15 | 25.00 mm | +16 / -8% | 34.7 mm | 35.8 mm | 40°C / 540 °C | 60 g | x |

US Customary Units

| MODEL | GAGE LENGTH | MEASURING RANGE (% STRAIN) | HEIGHT | LENGTH | TEMPERATURE RANGE MIN/MAX* | ACTIVATION FORCE | INCLUDES ATTACHMENT KIT |
|------------|-------------|----------------------------|--------|--------|----------------------------|------------------|-------------------------|
| 633.11L-15 | 1.000 in | +16 / -8% | 1.4 in | 2.2 in | 100°F to 1000°F | 60 g | x |

*May be used 25°C (50°F) higher than specified for short durations less than 24 hours.

Specialty Extensometers

Averaging Axial Extensometer

- » Simultaneously measures axial deflection on the opposite sides of the specimen and then sums those measurements to provide a single average strain output
- » Measuring strain on both sides of the specimen reduces errors in strain measurements caused by bending strains, resulting in more accurate elastic modulus values
- » Units can be used to perform testing on solid or tubular composite or metal specimens of almost any configuration
- » Easily adjustable from 3 mm to 32 mm (0.12 in to 1.26 in) in diameter for round specimens
- » Easily adjustable for up to 51 mm (2 in) width for flat specimens
- » Low strain range detects small displacement changes in ceramics and composites
- » Meets or exceeds requirements for calibration according to ASTM E83 Class B1 and ISO 9513 Class 0.5 standards

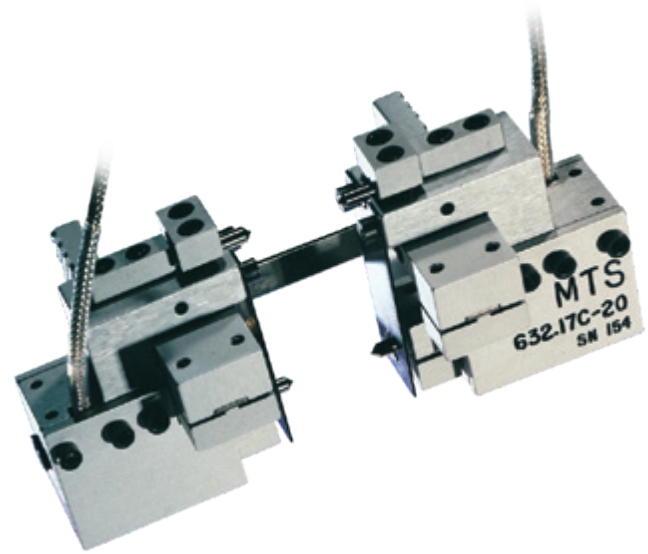

Metric Units

| MODEL | GAGE LENGTH | MEASURING RANGE (% STRAIN) | HEIGHT | LENGTH | DEPTH | TEMPERATURE RANGE MIN/MAX* | PART NUMBER |
|------------|-------------|----------------------------|---------|----------|---------|----------------------------|-------------|
| 632.17F-x0 | | | | | | | |
| 632.17F-40 | 10 ±0.05 mm | +12% / -5% | 63.5 mm | 101.6 mm | 38.1 mm | -100°C / 150°C | 047-404-802 |
| 632.17F-20 | 25 ±0.05 mm | +5% / -2% | 63.5 mm | 101.6 mm | 38.1 mm | -100°C / 150°C | 047-401-102 |

US Customary Units

| MODEL | GAGE LENGTH | MEASURING RANGE (% STRAIN) | HEIGHT | LENGTH | DEPTH | TEMPERATURE RANGE MIN/MAX* | PART NUMBER |
|------------|---------------|----------------------------|--------|--------|--------|----------------------------|-------------|
| 632.17E-x0 | | | | | | | |
| 632.17E-30 | 0.5 ±0.002 in | +10% / -4% | 2.5 in | 4.0 in | 1.5 in | -150°F / 300°F | 047-404-801 |
| 632.17E-20 | 1.0±0.002 in | +5% / -2% | 2.5 in | 4.0 in | 1.5 in | -150°F / 300° F | 047-401-101 |

*These units may be used at 25°C (50 °F) higher than the listed temperatures, but only for durations less than 24 hours.

Specialty Extensometers

Biaxial Extensometer

- » Measure the cross-sectional, diametral, or average axial strain with a single extensometer
- » Readily attach to many shapes and sizes of specimens
- » If you are worried about mechanical crosstalk between the axial and transverse channels, select Model 632.85x-05. This model operates only with conical point contacts.
- » If you have very thin specimens (i.e. sheet metal), select Model 632.85x-14. This model is designed for use with either conical point or v-chisel specimen contacts. Two output signals require separate conditioning for the averaged axial and the cross-sectional signals.
- » Meets or exceeds requirements for calibration according to ASTM E83 Class B1 and ISO 9513 Class 0.5 standards

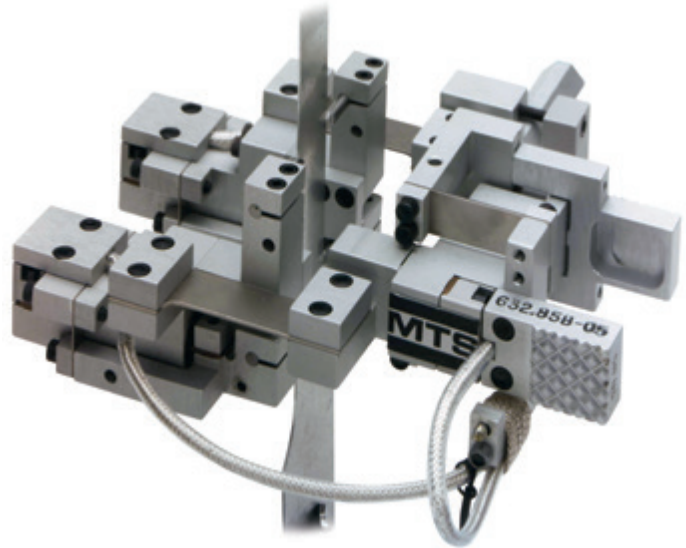

Metric Units

| MODEL | GAGE LENGTH | AXIAL TRAVEL | TRANSVERSE TRAVEL | HEIGHT | LENGTH | DEPTH | TEMPERATURE RANGE MIN/MAX* | PART NUMBER |
|------------|-------------|-------------------|-------------------|----------|---------|----------|----------------------------|-------------|
| 632.85F-xx | | | | | | | | |
| 632.85F-05 | 25±0.05 mm | +1.25 to -0.50 mm | ±0.5 mm | 101.6 mm | 38.1 mm | 101.6 mm | -100°C / 150°C | 047-403-502 |
| 632.85F-14 | 25±0.05 mm | +1.25 to -0.50 mm | 0.5 mm | 101.6 mm | 38.1 mm | 101.6 mm | -100°C / 150°C | 047-403-506 |

US Customary Units

| MODEL | GAGE LENGTH | AXIAL TRAVEL | TRANSVERSE TRAVEL | HEIGHT | LENGTH | DEPTH | TEMPERATURE RANGE MIN/MAX* | PART NUMBER |
|------------|----------------|---------------------|-------------------|--------|--------|--------|----------------------------|-------------|
| 632.85E-xx | | | | | | | | |
| 632.85E-05 | 1.000±0.002 in | +0.050 to -0.020 in | ±0.02 in | 4.0 in | 1.5 in | 4.0 in | -150°F / 300°F | 047-403-501 |
| 632.85E-14 | 1.000±0.002 in | +0.050 to -0.020 in | ±0.02 in | 4.0 in | 1.5 in | 4.0 in | -150°F / 300°F | 047-403-505 |

*These units may be used at 25°C (50 °F) higher than the listed temperatures, but only for durations less than 24 hours.

Specialty Extensometers

Cross-Sectional Strain Extensometer

- » Measures cross-sectional strain and when used with a long gage length or enhanced travel extensometers (pages 14 and 15), it is ideal for determining the “R” value for plastics and sheet metal
- » Free floating feature enables it to travel with the specimen as it is elongated during axial loading



Metric Units

| MODEL | GAGE WIDTH | TRAVEL | SPECIMEN THICKNESS | TEMPERATURE RANGE MIN/MAX* | CLAMP FORCE | PART NUMBER |
|------------|---------------|------------|--------------------|----------------------------|-------------|-------------|
| 632.23F-x0 | | | | | | |
| 632.23F-20 | 12.7 ± 0.5 mm | -4 to 0 mm | 0.5 to 5 mm | -100°C / 150°C | 400 g | 047-401-502 |
| 632.23F-30 | 20 ± 1 mm | -4 to 0 mm | 0.5 to 5 mm | -100°C / 150°C | 400 g | 047-401-504 |
| 632.23F-30 | 25 ± 1 mm | -4 to 0 mm | 0.5 to 5 mm | -100°C / 150°C | 400 g | 047-401-506 |

US Customary Units

| MODEL | GAGE WIDTH | TRAVEL | SPECIMEN THICKNESS | TEMPERATURE RANGE MIN/MAX* | CLAMP FORCE | PART NUMBER |
|------------|---------------|---------------|--------------------|----------------------------|-------------|-------------|
| 632.23E-x0 | | | | | 400 g | |
| 632.23E-20 | 0.5 ± 0.02 in | -0.16 to 0 in | 0.02 to 0.2 in | -150°F / 300°F | 400 g | 047-401-501 |

*These units may be used at 25°C (50 °F) higher than the listed temperatures, but only for durations less than 24 hours.

Specialty Extensometers

Diametral Extensometer

- » Ideal for measuring diametral strain in tension or compression
- » Designed for measuring cross sectional area changes on round specimens and helping to measure Poisson's ratio
- » Models available for testing at ambient, cryogenic, and elevated temperatures
- » Contact MTS for options for transverse measurements of specimens with rectangular cross sections

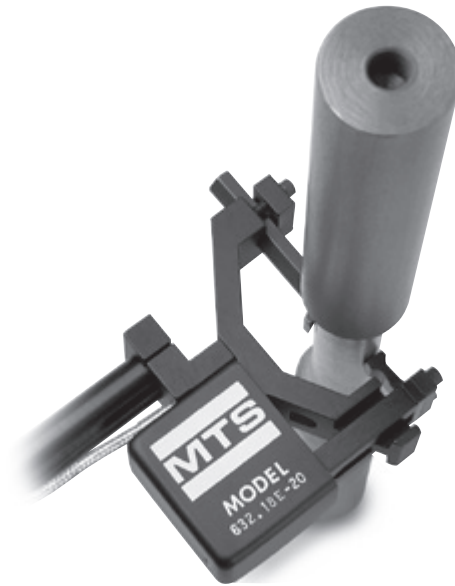

Metric Units

| MODEL | GAGE DIAMETER | TRAVEL | HEIGHT | LENGTH | TEMPERATURE RANGE MIN/MAX* | CLAMP FORCE | PART NUMBER |
|------------|-----------------|---------|---------|--------|-------------------------------|----------------|-------------|
| 632.18F-2x | 6.1 mm to 26 mm | ±2 mm | 12.7 mm | 191 mm | | | |
| 632.18F-20 | | | | | -100°C / 150 °C | 400 g | 047-401-204 |
| 632.18F-21 | | | | | -265°C / 65° C | 400 g | 047-401-205 |
| 632.19F-2x | 3.6 mm to 13 mm | ±1 mm | 12.7 mm | 191 mm | | | |
| 632.19F-20 | | | | | -100°C / 150 °C | 400 g | 047-401-304 |
| 632.20F-2x | 2 mm to 7.9 mm | ±0.5 mm | 12.7 mm | 191 mm | | | |
| 632.20F-20 | | | | | -100°C / 150 °C | 400 g | 047-401-404 |

US Customary Units

| MODEL | GAGE DIAMETER | TRAVEL | HEIGHT | LENGTH | TEMPERATURE RANGE MIN/MAX* | CLAMP FORCE | PART NUMBER |
|------------|--------------------|----------|--------|--------|-------------------------------|----------------|-------------|
| 632.18E-2x | 0.24 in to 1.02 in | ±0.08 in | 0.5 in | 7.5 in | | | |
| 632.18E-20 | | | | | -150°F / 300 °F | 400 g | 047-401-201 |
| 632.19E-2x | 0.14 in to 0.52 in | ±0.04 in | 0.5 in | 7.5 in | | | |
| 632.19E-20 | | | | | -150°F / 300 °F | 400 g | 047-401-301 |
| 632.20E-2x | 0.14 in to 0.31 in | ±0.02 in | 0.5 in | 7.5 in | | | |
| 632.20E-20 | | | | | -150°F / 300 °F | 400 g | 047-401-403 |

*These units may be used at 25°C (50 °F) higher than the listed temperatures, but only for durations less than 24 hours.

Specialty Extensometers

Immersible Extensometer

- » Provide accurate strain measurement while totally immersed in water or saline solution
- » Designed for both tension and fatigue testing up to 30 Hz
- » Accurately translates specimen displacement to the hermetically sealed LVDT using a patented parallel flexure system
- » Gage Length extenders to extend gage length to 200 mm (8.0 in)
- » AC conditioning required

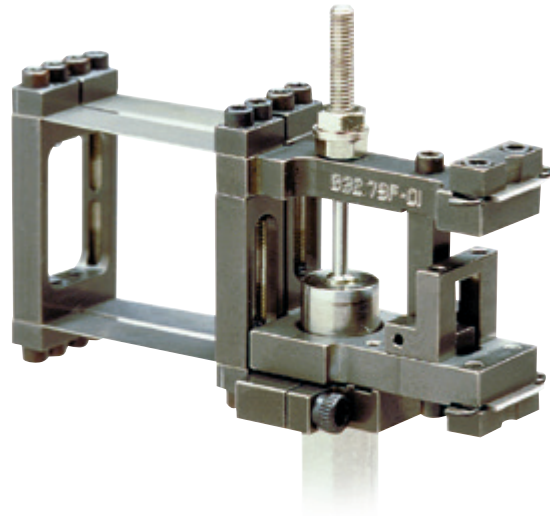

Metric Units

| MODEL | GAGE LENGTH | MEASURING RANGE (% STRAIN) | HEIGHT | LENGTH | TEMPERATURE RANGE MIN/MAX* | ACTIVATION FORCE | PART NUMBER |
|------------|-------------|-------------------------------|--------|---------|-------------------------------|---------------------|-------------|
| 632.79F-01 | 25 mm | ±20% | 76 mm | 69.1 mm | -15°C to 85°C | 60 g | 050-855-602 |

US Customary Units

| MODEL | GAGE LENGTH | MEASURING RANGE (% STRAIN) | HEIGHT | LENGTH | TEMPERATURE RANGE MIN/MAX* | ACTIVATION FORCE | PART NUMBER |
|------------|-------------|-------------------------------|--------|--------|-------------------------------|---------------------|-------------|
| 632.79E-01 | 1 in | ±20% | 3.0 in | 2.7 in | 4°F to 185°F | 60 g | 050-855-601 |

MTS Advantage™ Optical Extensometer (AOX)

As simple to use as a traditional contacting extensometer, the MTS Advantage™ Optical Extensometer (AOX) also provides all the precision and productivity advantages of a non-contacting strain measurement solution. Whether you are measuring QC tensile strength, long-term fatigue or crack growth, the MTS AOX optics packages can accommodate everything from the fine resolution measurements needed for low modulus ceramic and metallic materials, to the high-elongation requirements (>1000% strain) for viscoelastic plastic and elastomer materials. The MTS AOX is also an ideal solution for evaluating challenging specimens, such as those created from foils, fine wires and polymer films.

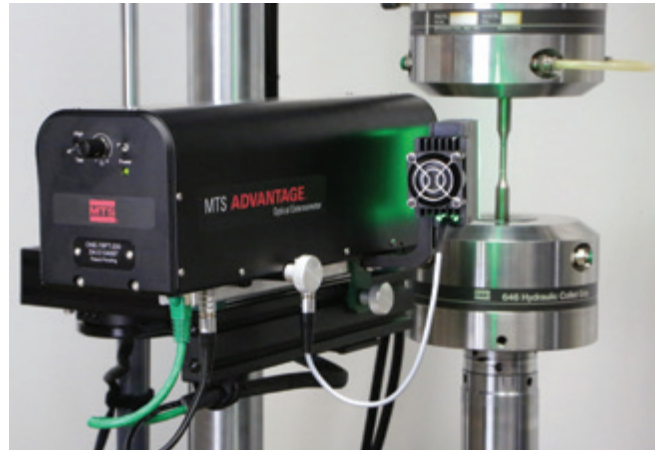

Advantages of Optical Extensometry

Faster Test Completion

Similar to a contacting extensometer, once the MTS AOX is set up, it is always measuring. This capability saves time, especially when running repetitive tests. Other productivity enhancements include:

- » **Faster Throughput:** Instant Reset feature auto-starts strain measurement for the next specimen, increasing productivity for repetitive QC testing
- » **Real-time Digital Output:** High-speed data stream with software tools for control and status
- » **No Post-processing Required:** Even when using the highest data rates, all data is sent directly to your test system.

Improved Accuracy

From pre-test calibration and alignment to reliable measurement, the MTS AOX provides the accuracy you require:

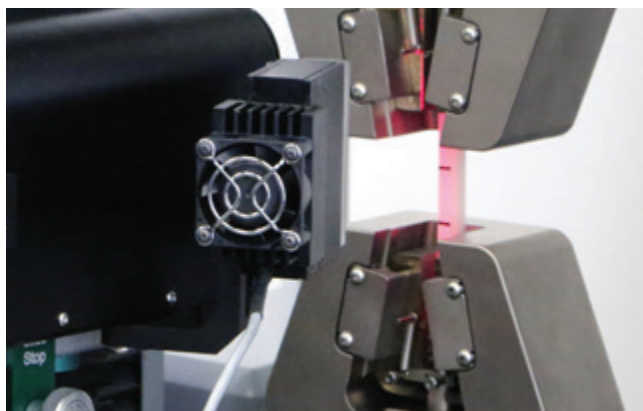

- » **A2LA Accredited Factory Calibration:** Fully calibrated using comprehensive processes to correct for scaling, skew, lens distortion, and uneven lighting
- » **Laser-Assist Alignment System:** Provides an instant visual check for specimen alignment and optics positioning
- » **Retractable, High-stiffness Mounting:** Maintains maximum dynamic range and vibration avoidance
- » **Reliable, Automatic Mark Detection:** Accurate tracking of bright or dark marks beyond 1000% strain and speeds >1500 mm/second
- » **Precision Telecentric Lens Option:** Helps compensate for out-of-plane measurement errors
- » **Robust Strain Control:** Built-in high-speed 16-bit analog output; not susceptible to unpredictable cyclic bias errors.

Simple Set-up & Operation

The MTS AOX runs on the test system computer and therefore does not require an additional computer and monitor. Other ways this extensometer simplifies testing:

- » **No Grids or Bars Required for Pre-test Calibration:** Can start your test sooner
- » **Multi-line Specimen Marking:** Optional methods automatically identify and report the region of highest strain concentration, in real-time
- » **Wide Range of Filter and Optical Settings:** Easily optimize performance for many different materials and specimens

Precision Telecentric Lens Packages

AOX PT lens systems are recommended for precision strain measurements (used for material strains <10%, normally metals, composites, etc.)

| Precision Telecentric Lens Systems | | | Typical Gage Lengths vs Maximum Strain/Travel | | |
|------------------------------------|---------------------|-----------------------|---|------------|----------------|
| Model Number | Field-of-View (FOV) | Working Distance (WD) | Gage Length | Max Strain | Max Elongation |
| AOX-52PT-System | 52 mm | 150 mm | 10 mm | 320% | 32 mm |
| | | | 12 mm | 250% | 30 mm |
| | | | 20 mm | 110% | 22 mm |
| | | | 25 mm | 65% | 17 mm |
| | | | 30 mm | 40% | 12 mm |
| 40 mm | 5% | 2 mm | | | |
| Model Number | Field-of-View (FOV) | Working Distance (WD) | Gage Length | Max Strain | Max Elongation |
| AOX-78PT-System | 78 mm | 200 mm | 10 mm | 580% | 58 mm |
| | | | 12 mm | 470% | 56 mm |
| | | | 20 mm | 240% | 48 mm |
| | | | 25 mm | 170% | 43 mm |
| | | | 50 mm | 35% | 18 mm |
| 65 mm | 5% | 3 mm | | | |
| Model Number | Field-of-View (FOV) | Working Distance (WD) | Gage Length | Max Strain | Max Elongation |
| AOX-130PT-System | 130 mm | 210 mm | 10 mm | ≥1000% | 110 mm |
| | | | 12 mm | 900% | 108 mm |
| | | | 25 mm | 380% | 95 mm |
| | | | 50 mm | 140% | 70 mm |
| | | | 75 mm | 60% | 45 mm |
| 100 mm | 20% | 20 mm | | | |

Conventional Entocentric Lens Packages

AOX CE lens systems are recommended for higher strain measurements (used for material strains >10%, normally plastics, elastomers, etc.)

| Conventional Entocentric Lens Systems | | | Typical Gage Lengths vs Maximum Strain/Travel | | |
|---------------------------------------|---------------------|-----------------------|---|------------|----------------|
| Model Number | Field-of-View (FOV) | Working Distance (WD) | Gage Length | Max Strain | Max Elongation |
| AOX-200CE-System | 200 mm | 220 mm | 10 mm | >1000% | 180 mm |
| | | | 25 mm | 660% | 165 mm |
| | | | 50 mm | 280% | 140 mm |
| | | | 75 mm | 150% | 115 mm |
| | | | 100 mm | 90% | 90 mm |
| | | | 150 mm | 25% | 40 mm |
| 180 mm | 5% | 10 mm | | | |
| Model Number | Field-of-View (FOV) | Working Distance (WD) | Gage Length | Max Strain | Max Elongation |
| AOX-250CE-System | 250 mm | 280 mm | 10 mm | >1000% | 230 mm |
| | | | 25 mm | 860% | 215 mm |
| | | | 50 mm | 380% | 190 mm |
| | | | 75 mm | 220% | 165 mm |
| | | | 100 mm | 140% | 140 mm |
| | | | 150 mm | 60% | 90 mm |
| 200 mm | 20% | 40 mm | | | |
| Model Number | Field-of-View (FOV) | Working Distance (WD) | Gage Length | Max Strain | Max Elongation |
| AOX-500CE-System | 500 mm | 270 mm | 10 mm | ≥1000% | 480 mm |
| | | | 25 mm | ≥1000% | 465 mm |
| | | | 50 mm | 880% | 440 mm |
| | | | 100 mm | 390% | 390 mm |
| | | | 200 mm | 145% | 290 mm |
| | | | 300 mm | 63% | 190 mm |
| 400 mm | 23% | 90 mm | | | |

» The MTS AOX will work with any gage length that is within the range for the lens options that are listed above.

» The maximum strain values are approximate and include a margin of 5-10 mm to provide for reasonable ease-of-use.

» A gage length of 4 times (or more) of the specimen width or diameter is recommended for most applications.

* Additional Working Distance and Field-of-View options are available.

MTS Advantage™ Video Extensometer

The MTS Advantage Video Extensometer delivers the flexibility, accuracy and repeatability needed in applications where it is difficult to measure strain using conventional means. This extensometer combines several features that make it an outstanding choice to measure strain, rotation and displacement of plastics, metals, composites and high-elongation materials.

- » Magnetic-return support arm for easy specimen access and precise positioning
- » Sixteen quick-attach measurement heads supporting a wide array of gage lengths and strain ranges
- » Pass/fail calibration verification blocks and software calibration wizard to confirm setup to desired ASTM E83 or ISO 9513 class
- » Mounting options on left, right, front or back of load frame

Advantages of Video Extensometry

- » Measures samples through failure without the risk of damage to your extensometer
- » Perfect for fragile, brittle or irregularly shaped specimens
- » Allows up to 200 measurements in real-time
- » Allows repeatable measurements to be made after the physical test is complete
- » Ideal option for measuring in high-temperature or submerged

User-friendly Software Enables Quick Measurements

- » Drag and drop a full selection of measurement devices onto your specimen
- » Select from 10 different measurement devices to determine position, displacement, distance or rotation
- » Virtual strain measurement devices convert motion into axial strain, dual average strain, Poisson's ratio, shear strain and 2D strain maps
- » Understand results quickly with intuitive graphical displays
- » Ethernet communication between systems sends ± 10 V signals to the MTS TestSuite TW software

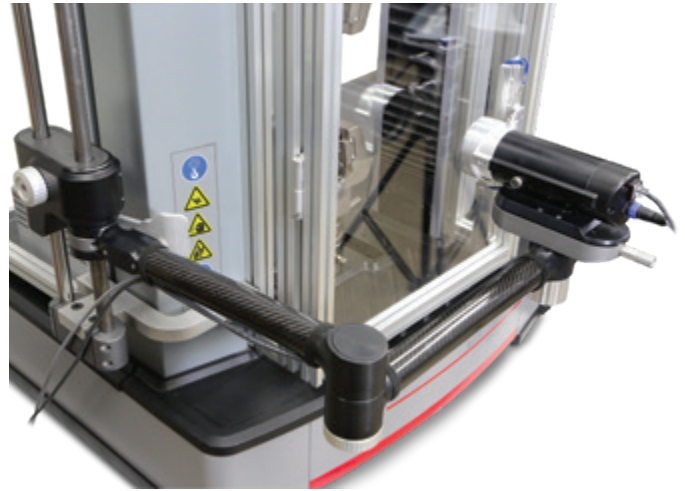

Upgrade to 2D Digital Image Correlation (DIC)

- » Create planar strain maps with real-time measurements
- » Output 2D contour plots where color gradients show levels of strain
- » Define the x-axis and show E_{xx} , E_{yy} or E_{xy}
- » Identify areas of high stress, crack option or other discontinuities
- » Toggle between all measurement options without reprocessing a test

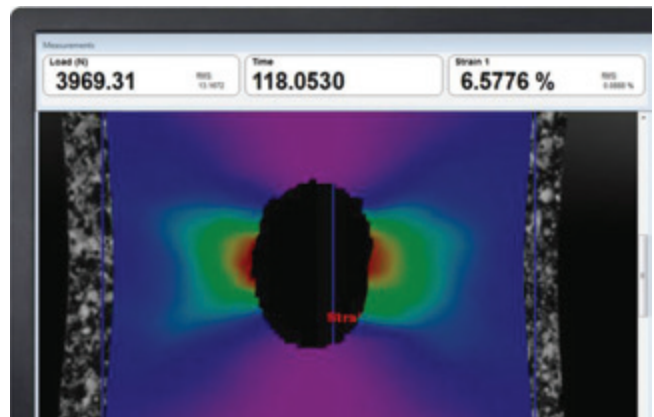

2D Strain Map

Measurement Head Specifications

Each AVX Measurement Head includes an inspected, traceable validation block, which can be used to confirm calibration at the beginning of a series of tests. Validation blocks are serialized and include an ISO 17025 Accreditation Calibration Report.

XT-100 Series Measurement Heads

Ideal for determining higher strain (>10%) materials properties such as yield point & elongation, and for long gage lengths. All models are capable of meeting Class B-2 (ASTM E-83) & Class 0.5 (ISO 9513) at the specified gage lengths and strain ranges (>10%).

They are also capable of meeting Class B-1 (ASTM E-83) over most of their operating range (gage lengths where maximum axial tensile strain less than 600%). The XT-100 series operate at measurement rates from 0.1 - 500 Hz.



| AVX Measurement Head | Maximum Axial Tensile Strain Range (%) at Specified Gage Length (mm) ¹ | | | | | Maximum Axial Compressive Strain Range (%) at Specified Gage Length (mm) ¹ | | | | | Maximum Transverse Gage Length (mm) ² | Typical Extension Resolution (μm) ³ | Minimum Specimen Width for Measurements (mm) ⁴ | | Maximum Tracking Speed (mm/min) ² | Field of View (mm) |
|----------------------|---|------|-----|-----|-----|---|----|----|-----|-----|--|--|---|------------|--|--------------------|
| | 10 | 25 | 50 | 100 | 200 | 10 | 25 | 50 | 100 | 200 | | | Axial | Transverse | | |
| XT-101 | 280 | 70 | - | - | - | 40 | 40 | - | - | - | 10 | 0.3 | 1.5 | 4 | 1350 | 57 x 16 |
| XT-102 | 530 | 170 | 50 | - | - | 40 | 40 | 40 | - | - | 19 | 0.4 | 2.4 | 7 | 2100 | 98 x 27 |
| XT-103 | 840 | 300 | 120 | 25 | - | - | 40 | 40 | 40 | - | 29 | 0.6 | 3.4 | 10 | 3200 | 150 x 42 |
| XT-104 | 1000 | 460 | 200 | 65 | - | - | 40 | 40 | 40 | - | 43 | 0.9 | 5 | 14 | 4600 | 220 x 62 |
| XT-105 | - | 800 | 360 | 150 | 40 | - | - | 40 | 40 | 40 | 70 | 1.4 | 8 | 23 | 7200 | 350 x 100 |
| XT-106 | - | 1000 | 500 | 220 | 70 | - | - | 40 | 40 | 40 | 65 | 1.8 | 11 | 30 | 9400 | 460 x 100 |
| XT-107 | - | - | 800 | 360 | 150 | - | - | - | 40 | 40 | - | 2.8 | 16 | - | 14000 | 700 x 100 |

1. Strain ranges assume a distance between the grips of twice the GL, with a centrally positioned gage. Actual strain ranges may be greater or less than these values, depending on gage positioning, grip separation and specimen behavior.
2. Maximum transverse GL and tracking speed is quoted at a measurement rate of 100 Hz.
3. Resolution is based on typical lab performance.
4. For Class B-1, minimum specimen width for transverse gage lengths should be increased by 65%.

Note: Working distance is 480 mm.

XT-200 Series Measurement Heads

Ideal for determining low strain materials properties (from 0.01%), such as tensile & compressive modulus, Poisson's ratio & R-value. All models are capable of meeting Class B-1 (ASTM E-83) & Class 0.5 (ISO 9513) at the specified gage lengths and strain ranges.

The XT-200 series are our highest accuracy measurement heads. These models operate at measurement rates from 0.1 - 30 Hz. The XT-250 series are suitable for many high accuracy dynamic applications, and operate at measurement rates from 0.1 - 500 Hz.



| AVX Measurement Head | Maximum Axial Tensile Strain Range (%) at Specified Gage Length (mm) ¹ | | | Maximum Axial Compressive Strain Range (%) at Specified Gage Length (mm) ¹ | | | Maximum Transverse Gage Length (mm) ² | Typical Extension Resolution (μm) ³ | Minimum Specimen Width for Measurements (mm) | | Maximum Tracking Speed (mm/min) ² | Field of View (mm) |
|----------------------|---|-----|----|---|----|----|--|--|--|------------|--|--------------------|
| | 10 | 25 | 50 | 10 | 25 | 50 | | | Axial | Transverse | | |
| XT-204 | 300 | 80 | 10 | 40 | 40 | 25 | 45 | 0.18 | 1.0 | 4.6 | 250 | 61 x 51 |
| XT-205 | 460 | 145 | 40 | 40 | 40 | 40 | 63 | 0.25 | 1.4 | 6.4 | 350 | 86 x 72 |
| XT-254 | 390 | 120 | 25 | 40 | 40 | 40 | 15 | 0.3 | 1.7 | 8 | 1900 | 76 x 21 |
| XT-255 | 580 | 190 | 65 | 40 | 40 | 40 | 21 | 0.4 | 2.4 | 11 | 2600 | 107 x 30 |

1. Specified strain ranges assume a distance between the grips of twice the GL, with a centrally positioned gage. Actual strain ranges may be greater or less than these values, depending on gage positioning, grip separation and specimen behavior.
2. Maximum transverse GL and tracking speed is quoted at a measurement rate of 15Hz (XT-20x series) and 100 Hz (XT-25x series).
3. Resolution based on typical lab performance.

Note: Working distance is 273 mm and is subject to +/- 5% tolerance.

Laser Extensometer

MTS offers the LX 500 Extensometer. This high performance device is completely self-contained, easily transportable, and easy to use with its digital display and four-button keypad. It can be operated from the rear control panel or remotely via the RS-232 interface. The unique scanning laser beam technique, used to measure elongation entirely from one side of the specimen, eliminates the need for a separate receiver mounted on the opposite side of the specimen.

FEATURES

- » Selectable averaging of 2 to 512 scans
- » Measures the initial gage length of the specimen directly
- » Can measure strain simultaneously over three segments within the specimen's gage length
- » Meets ASTM B1 extensometer classification (25 mm/1 in and longer gage length)
- » Measurements are updated 100 times per second.
- » Analog output port for closed loop strain control or for input to a data acquisition board, chart recorder, and so forth
- » Parallel beam design accommodates operation through chamber glass, a clear bath, water, and so forth
- » Certified for compliance with the Center for Devices and Radiological Health as a Class II product



| MODEL | MAXIMUM TRAVEL | RESOLUTION | NON-LINEARITY MAXIMUM | REPEATABILITY | ANALOG OUTPUT | PART NUMBERS* 115V±10% | PART NUMBERS* 230V±10% |
|--------|--------------------------|-------------------------|--------------------------|---------------------------|---|------------------------|------------------------|
| LX 500 | 8-127 mm (0.3-5.0 in) | 0.001 mm (0.0001 in) | ±0.025 mm (±0.001 in) | ±0.003 mm (±0.0001 in) | 16 bit selectable range, ±10 V full scale | 055-283-101 | 055-283-102 |

*Includes tripod, mounting plates, instruction manual, line cord, and tripod head.

| ACCESSORIES | MEASUREMENT | PART NUMBERS |
|--|----------------------------------|--------------|
| Retroreflective Tape | 3.2 mm x 7.6 m (1/8 in x 25 ft) | 100-039-188 |
| Retroreflective Tape | 6.4 mm x 7.6 m (1/4 in x 25 ft) | 100-039-189 |
| Retroreflective Tape, Submersible (water) | 3.2 mm x 7.6 m (1/8 in x 25 ft) | 100-214-873 |
| Retroreflective Target, High Temp. (900°F), Non-adhesive | 2.5 mm x 76.2 mm (0.1 in x 3 in) | 100-039-190 |
| Laser Cart, Vertical Adjustment | 913 mm x 1556 mm (36 in x 61 in) | 100-165-138 |

Other Applications

With over 101 different models, MTS has the largest offering of extensometers in the world. In fact, here's a list of some of our other models that you won't find in this catalog. Contact us if you're interested in any of these capabilities!

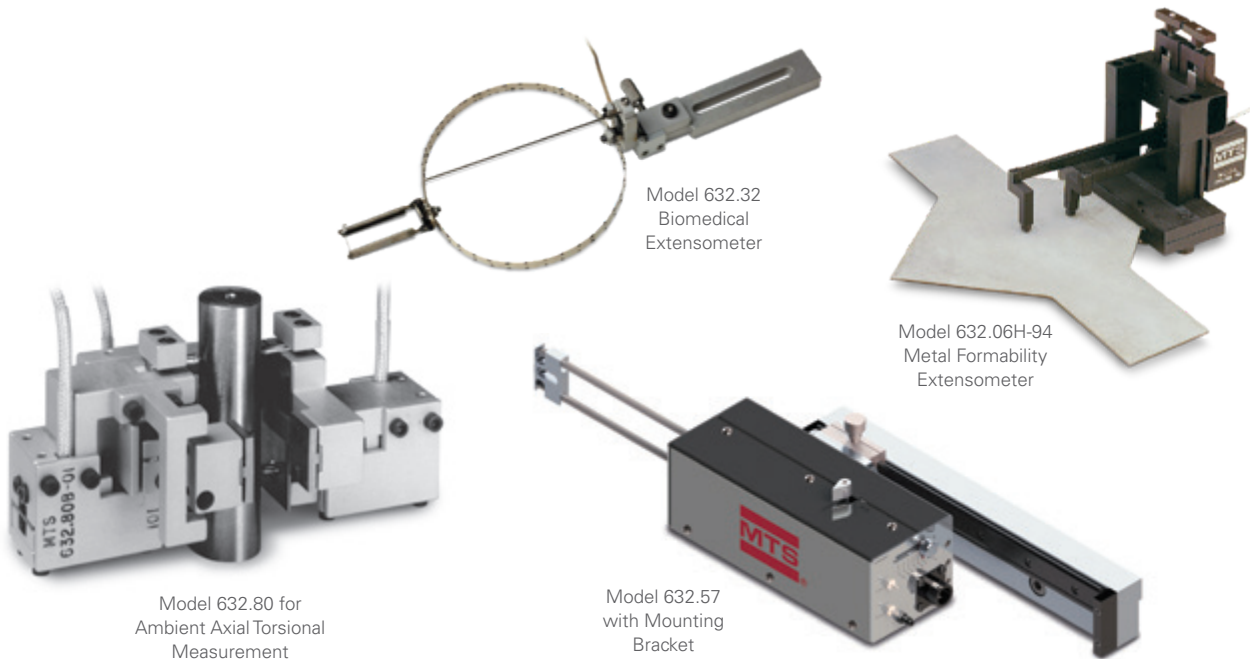

BIOMEDICAL SOFT TISSUE OR SIMILAR MATERIAL (MODEL 632.32)

Ultra-low contact force with serrated knife edges.

HIGH-TEMPERATURE AXIAL APPLICATIONS (MODELS 632.50/ .51/ .53/ .54/ .57)

Many options available. Air-cooled, water-cooled, vacuum, and temperatures to 1600°C (2900°F).

HIGH-TEMPERATURE DIAMETRAL/TRANSVERSE APPLICATIONS (MODELS 632.60/61)

Standard models to 1000°C (2200°F).

HIGH-TEMPERATURE AXIAL TORSIONAL APPLICATIONS (MODELS 632.68 AND 632.80)

Simultaneous measurement of axial and torsional strain. The Model 632.80 has a temperature range of -100°C to 150°C (-150°F to 300°F), while the high-temperature version Model 632.68 is rated up to 1200°C (2200°F).

AXIAL ROCK MECHANICS APPLICATION (MODEL 632.90)

Models available for use in air, or in high pressure, single measurement, and averaged axial applications.

CIRCUMFERENTIAL APPLICATION (MODEL 632.92)

Unique roller chain design provides low hysteresis.



Clip-On Displacement Gages

- » Double cantilever displacement-type gages are primarily used in fracture mechanics testing, K_{IC} , J_{IC} , crack growth and R-curve determination
- » Useful for measuring the displacements of components and specimens with odd geometries, performing elongation studies, and testing pipes, bars and rods
- » Compatible with a variety of specimens including compact tension, WOL, round compact tension, C-shaped, bend, and other common specimens or panels
- » Can be immersed in a wide variety of non-conductive fluids without special precautions
- » Model 632.02 Clip-On gages when testing to ASTM E399
- » Model 632.03 Clip-On Gages are our most accurate featuring improved slot geometry and three-point contact knife edges. Options are available with longer travel for J-integral and crack growth tests
- » Replacement knife edges available upon request
- » Additional models available, contact your sales representative for more options

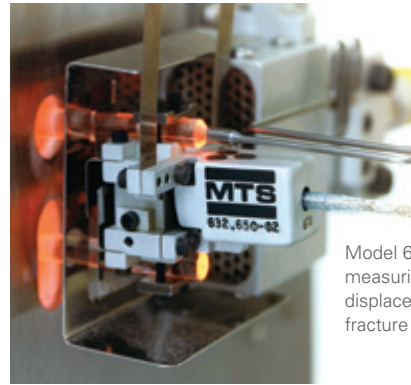

Model 632.65 is ideal for measuring crack opening displacement for hot fracture mechanics testing.



Pictured are 632.02 and 632.03/05 Clip-On Gage knife edges.

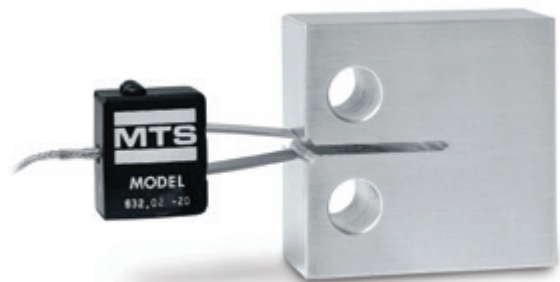

Standard equipment includes the gage and storage case, two reusable hardened knife edges for attachment to the specimen, and an instruction manual.

Metric Units

| MODEL/OPT | GAGE LENGTH | TRAVEL | MAXIMUM FREQUENCY | COMPRESSED FORCE | HEIGHT/LENGTH | TEMPERATURE MIN/MAX | PART NUMBER |
|------------|-------------|---------------|-------------------|------------------|----------------|---------------------|-------------|
| 632.02F-2x | 5 mm | +3 / -1 mm | 50 Hz | 2500 g | 30.5 / 48.3 mm | | |
| 632.02F-20 | | | | | | -100°C / 150°C | 047-400-104 |
| 632.03-2x | 12 mm | 4 mm | 100 Hz | 2500 g | | | |
| 632.03F-20 | | | | | | -100°C / 150°C | 047-400-204 |
| 632.03-3X | | | | | | | |
| Option 001 | 2 mm | 4 mm | | | | -100°C / 150°C | 047-400-310 |
| Option 002 | 2.5 mm | 4 mm | | | | -100°C / 150°C | 047-400-311 |
| 632.65E-03 | 15.24 mm | +10 / -1.0 mm | 10 Hz | 200 g | | 1000°C max | |

US Customary Units

| MODEL/OPT | GAGE LENGTH | TRAVEL | MAXIMUM FREQUENCY | COMPRESSED FORCE | HEIGHT/LENGTH | TEMPERATURE MIN/MAX | PART NUMBER |
|----------------|-------------|--------------------|-------------------|------------------|---------------|---------------------|-------------|
| 632.02E-2x / - | 0.2000 in | +0.100 / -0.05 in | 50 Hz | 2500 g | 1.2 / 1.9 in | | |
| 632.02E-20 | | | | | | -150°F / 300°F | 047-400-101 |
| 632.03E-20 | 0.475 in | 0.15 in | 100 Hz | 2500 g | | | |
| | | | | | | -150°F / 300°F | 047-400-201 |
| 632.03E-3X | | | | | | | |
| Option 001 | 0.075 in | 0.15 in | | | | -150°F / 300°F | 047-400-301 |
| Option 002 | 0.10 in | 0.15 in | | | | -150°F / 300°F | 047-400-302 |
| 632.65E-03 | .600 in | +0.400 / -0.040 in | 10 Hz | 200 g | | 1800°F max | |

Displacement Gages

- » Versatile design measures specimens, fixtures, shafts, or the movement of any other component during a test
- » Designed for use where small deformations must be measured such as bend tests or tests with unusual geometries
- » Over-travel protection included:
 - Gage arm releases if it travels too far or when a side load is applied.
 - Gage arm can be reset without changing the body position
- » Comes with an adjustable mounting block
- » Displacement measurements can be made with the gage in contact against a specimen or an active component in the force train

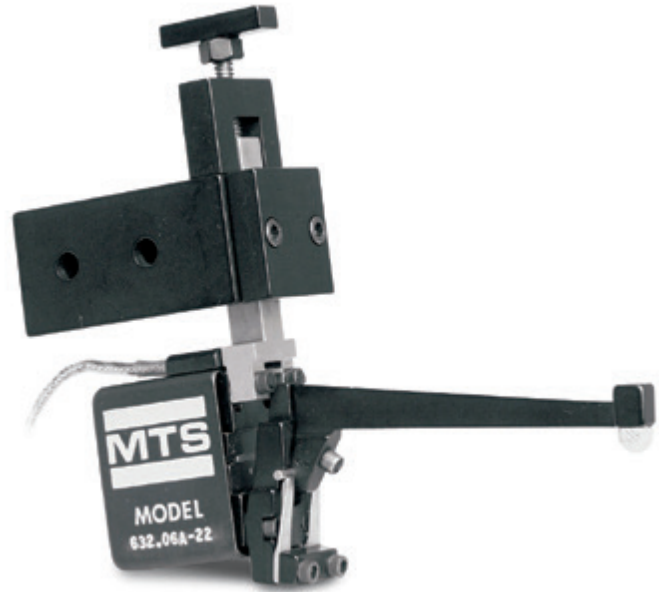

| MODEL/OPT | TRAVEL | ZERO ADJUST | FORCE AT ZERO | HEIGHT | LENGTH | TEMPERATURE RANGE MIN/MAX | PART NUMBER |
|-----------------|---------------------|----------------|---------------|---------------|------------------|---------------------------------|-------------|
| 632.06H-2x / - | ±4 mm (±0.16 in) | 8 mm (0.30 in) | 150 g | 101 mm (4 in) | 101 mm (4 in) | -100°C / 150°C (-150°F / 300°F) | 047-400-501 |
| 632.06H-20 | | | | | | -100°C / 175°C (-150°F / 350°F) | 047-400-503 |
| 632.06H-23 | | | | | | -100°C / 175°C (-150°F / 350°F) | 047-400-503 |
| 632.06H-3x/ 001 | ±2 mm (±0.08 in) | 8 mm (0.30 in) | 150 g | 101 mm (4 in) | 101 mm (4 in) | -100°C / 150°C (-150°F / 300°F) | 047-400-504 |
| 632.06H-30 | | | | | | -100°C / 175°C (-150°F / 350°F) | 047-400-506 |
| 632.06H-33 | | | | | | -100°C / 175°C (-150°F / 350°F) | 047-400-506 |
| 632.06H-3x/ 002 | ±1 mm (±0.04 in) | 8 mm (0.30 in) | 250 g | 101 mm (4 in) | 69 mm (2.7 in) | -100°C / 150°C (-150°F / 300°F) | 047-400-507 |
| 632.06H-30 | | | | | | -100°C / 150°C (-150°F / 300°F) | 047-400-507 |
| 632.06H-3x/ 003 | ±6 mm (±0.25 in) | 8 mm (0.30 in) | 150 g | 101 mm (4 in) | 101 mm (4 in) | -100°C / 150°C (-150°F / 300°F) | 047-400-510 |
| 632.06H-30 | | | | | | -100°C / 175°C (-150°F / 350°F) | 047-400-512 |
| 632.06H-33 | | | | | | -100°C / 175°C (-150°F / 350°F) | 047-400-512 |
| 632.06H-3x/ 004 | ±8 mm (±0.32 in) | 8 mm (0.30 in) | 100 g | 101 mm (4 in) | 140 mm (5.5 in) | -100°C / 150°C (-150°F / 300°F) | 047-400-513 |
| 632.06H-30 | | | | | | -100°C / 150°C (-150°F / 300°F) | 047-400-513 |
| 632.06H-3x/ 005 | ±12.5 mm (±0.50 in) | 8 mm (0.30 in) | 80 g | 101 mm (4 in) | 190 mm (7.5 in) | -100°C / 150°C (-150°F / 300°F) | 047-400-516 |
| 632.06H-30 | | | | | | -270°C / 65°C (-452°F / 150°F) | 047-400-517 |
| 632.06H-31 | | | | | | -270°C / 65°C (-452°F / 150°F) | 047-400-517 |
| 632.06H-33 | | | | | | -100°C / 175°C (-150°F / 350°F) | 047-400-518 |
| 632.06H-3x/ 006 | ±25 mm (±0.50 in) | 8 mm (0.30 in) | 35 g | 101 mm (4 in) | 343 mm (13.5 in) | -100°C / 150°C (-150°F / 300°F) | 047-400-519 |
| 632.06H-30 | | | | | | -100°C / 150°C (-150°F / 300°F) | 047-400-519 |
| 632.06H-31 | | | | | | -270°C / 65°C (-452°F / 150°F) | 047-400-520 |

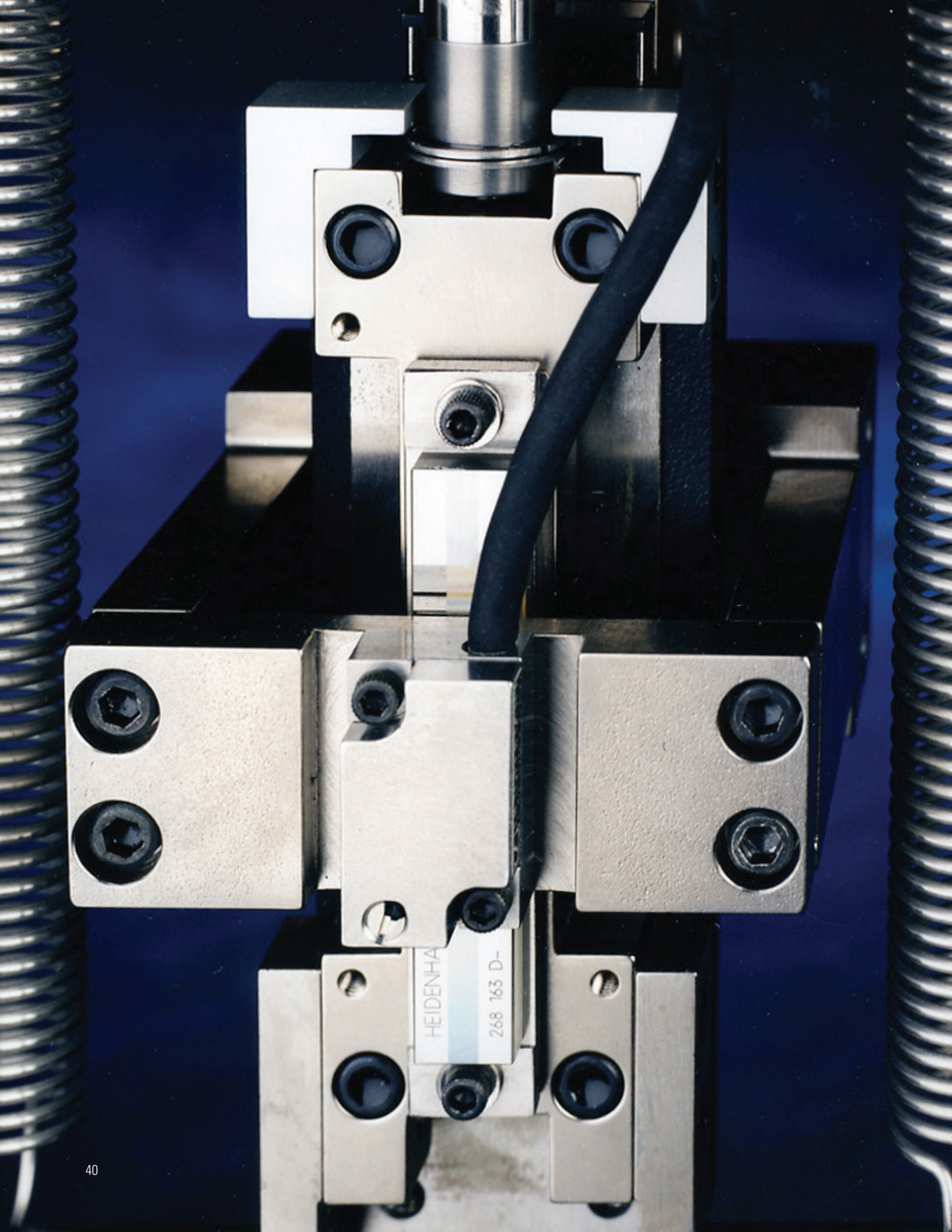

Extensometer Calibrator



Model 650.03
Extensometer
Calibrator with
axial setup

Model 650.03

The MTS Model 650.03 Extensometer Calibrator is a precise instrument designed and built for rugged, long-lasting durability. It gives you freedom from wear; vital for the high accuracy required for precise calibrator verification of high resolution instruments.

The micrometer head has a spindle with a large diameter lead screw to reduce wear and resulting backlash and to provide higher strength and stiffness. Larger mounting diameters reduce the unit stress required in mounting the micrometer head to the frame.

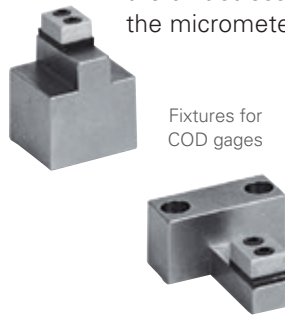

Fixtures for
COD gages

The micrometer head is large for easy readability, accurate adjustment, and improved repeatability of gage calibration.

1. Standard Axial includes Extensometer models 632.11/12/13/24/25/26/27/31, 634.11/12/25/31 set-up with straight knife edges and attachment for round specimens. Some specific knife edges or attachment kits may require other sizes of specimen adapters. The installation drawing for the extensometer will identify the specimen size range.

2. Standard High Temperature Axial includes 632.53/54 with standard length rods, 632.50/51 with length options 075, 076, 077,078, 079 and 080. Calibration require rods with either conical point (with Dimpled Specimen) or V-chisel rod end geometry (with optional 9.5 mm round).

| EXTENSOMETER MODEL | 632.02 | 632.03/.05 | STANDARD AXIAL (1) | EXTENDED GL AXIAL | 632.06 | 632.06 OPTION 006 | 632.18/.19/.20 | 632.29 | 632.17/.85 AXIAL | 632.85 TRANSVERSE | STANDARD HI TEMP AXIAL (2) | 632.92, 632.11 OR .12 W/ 632.21 KIT |
|--------------------|--------|------------|--------------------|-------------------|--------|-------------------|----------------|--------|------------------|-------------------|----------------------------|-------------------------------------|
|--------------------|--------|------------|--------------------|-------------------|--------|-------------------|----------------|--------|------------------|-------------------|----------------------------|-------------------------------------|

| | | | | | | | | | | | | |
|---|-------------|------------------------------|--|--|--|--|--|--|--|--|--|--|
| 650.03 Calibrator frame in fitted case | 031-508-302 | Required for all | | | | | | | | | | |
| Micrometer head, U.S. customary (0.00005 in graduation) | 031-508-205 | Required for all, choose one | | | | | | | | | | |
| Micrometer head, Metric (0.001 mm graduation) | 031-508-206 | Required for all, choose one | | | | | | | | | | |

Calibrator Kits

| | | | | | | | | | | | | |
|--|-------------|---|---|-----|---|---|---|--|---|-----|---|---|
| Calibrator Kit, Basic Specimen Adapters | 100-049-249 | • | • | opt | | | | | • | • | | • |
| Calibrator Kit, Model 632.03/.05 Knife Edges | 100-049-250 | | • | | | | | | | | | |
| Calibrator Kit, Model 632.02 Knife Edges | 100-049-251 | • | | | | | | | | | | |
| Calibrator Kit, Standard, 12.7 mm (0.50 in), Round Spec. | 100-049-270 | | | • | • | | | | | | | |
| Calibrator Kit, Frame Invert | 100-049-252 | | | | • | • | • | | | | | • |
| Calibrator Kit, Extended, 12.7 mm (0.50 in), Round Spec. | 100-049-253 | | | | • | | | | | | | |
| Calibrator Kit, Dimpled, 9.5 mm (0.375 in) Round Spec. | 100-054-156 | | | | | | | | | | | • |
| Calibrator Kit, 9.5 mm (0.375 in) Round Specimen | 100-049-255 | | | opt | | | | | | opt | | |
| Calibrator Kit, 3.2 mm (0.125 in) Round Specimen | 100-049-256 | | | opt | | | | | • | | | |
| Calibrator Kit, Mounting Bracket for Model 632.53/.54 | 100-054-133 | | | | | | | | | | | • |
| Calibrator Kit, Model 632.18/.19/.20 Diametral Extensometers | 100-049-258 | | | | | | • | | | | | |
| Calibrator Kit, Displacement Gages | 100-049-259 | | | | • | • | | | | | | |
| Calibrator Kit, Model 632.06 Option 006 Adapter | 100-054-796 | | | | | • | | | | | | |
| Calibrator Kit, Model 632.17/.85 Axial | 100-049-260 | | | | | | | | • | | | |
| Calibrator Kit, Model 632.85 Transverse | 100-049-261 | | | | | | | | | • | | |
| Calibrator Kit, Model 632.92/.21 Circumferential | 100-049-262 | | | | | | | | | | • | |

Find the model of the extensometer, then follow the column down to determine the kit(s) required to calibrate the extensometer.

MTS Direct Current Potential Drop (DCPD) Solution

Integrated Software & Hardware Package Allowing Accurate and Efficient Measurement of Fatigue Crack Growth

Direct Current Potential Drop (DCPD) measures the change in resistance of a specimen, which correlates directly with crack growth. It is an effective way to collect fatigue crack growth data in high-temperature tests and other challenging environments. DCPD is used to overcome the challenges that make contact extensometry and compliance calculations impractical for crack length measurement. Unfortunately, to get the best results, some DCPD solutions require excessive set-up time while others limit flexibility.

The MTS DCPD Solution features integrated software and hardware for test control, data analysis, and results reporting. It greatly simplifies DCPD test configuration using the powerful automation tools built into MTS TestSuite software. Integrated into MTS FlexTest 40 Controllers and MTS TestSuite Software, the MTS DCPD solution eliminates the challenges that can arise with non-integrated components from multiple suppliers. This provides a convenient and comprehensive way to incorporate DCPD into your material testing programs.

This solution uses the reversing DCPD method. By monitoring load and potential (voltage) data from a loaded specimen and a reference specimen, it determines crack length by calculating ratios of potential on both. Applying a calibration equation to the ratios produces the crack length. The current is switched on and off (reversed) to correct for thermocouple effects.

Comprehensive DCPD Solution

This solution offers a comprehensive approach for adding DCPD to your materials testing program. It includes the software and hardware required for integrated DCPD test development and execution. The MTS DCPD Testing Solution includes:

- » High-fidelity MTS DCPD Measurement System (2- or 7-channel configuration)
- » Modular Preamplifier(s)
- » MTS TestSuite DCPD Module supports 2-channel DCPD system (includes all test templates, report templates and calculations for ASTM-compliant fatigue crack growth assessments). Support for DCPD systems greater than 2 channels is available upon request
- » Includes MTS TestSuite Multipurpose Analyzer for automated or manual analysis
- » Required software (not included): MPE or MPX and Microsoft Excel 2016 or newer to view reports



- » Recommended software: MTS Reporter to create or edit reports post-test and to create or edit report templates
- » Setup specimen kit for verifying hardware setup and test configuration
- » Setup, installation and equipment verification by MTS
- » Additional training, consulting and template modifications are available.

KEY FEATURES

- » Compatible with MTS Series 318 and MTS Landmark® test systems for electrical isolation
- » Integrates with MTS FlexTest Controller (Model 40) and MTS TestSuite Software
- » Designed for low noise
- » Modular Preamplifier maintains signal integrity
- » Compliant to CE, CSA and NRTL
- » Available with advanced consultation, template changes and training.

Overall

| | |
|----------------|-----------------------------------|
| Current: | Adjustable 0 - 20 Amps DC Maximum |
| Voltage: | 5 Volts DC Maximum |
| Gain: | x 5,000 or x 50,000 |
| Gain Accuracy: | 0.5% Typical, 2% Maximum |
| Filter: | 50 Hz and 300 Hz |
| Bandwidth: | 300 Hz Maximum |
| Output: | ±10 Volts DC |

Main Chassis

| | |
|-------|-----------|
| Gain: | 1x or 10x |
|-------|-----------|

Preamp

| | |
|-------|--------|
| Gain: | 5,000x |
|-------|--------|

NOTES

Regional Business Centers

THE AMERICAS

MTS Systems Corporation

14000 Technology Drive
Eden Prairie, MN 55344-2290

USA

Telephone: 952-937-4000

Toll Free: 800-328-2255

E-mail: info@mts.com

Internet: www.mts.com

EUROPE

MTS Systems France

BAT EXA 16
16/18 rue Eugène Dupuis
94046 Créteil Cedex

France

Telephone: +33-(0)1-58 43 90 00

E-mail: contact.france@mts.com

MTS Systems (Germany) GmbH

Hohentwielsteig 3
14163 Berlin

Germany

Telephone: +49-(0)30 81002-0

E-mail: euroinfo@mts.com

MTS Systems S.R.L. a socio unico

Strada Pianezza 289
10151 Torino

Italy

Telephone: +39-(0)11 45175 11 sel. pass.

E-mail: mtstorino@mts.com

MTS Systems Norden AB

Datavägen 37b
SE-436 32 Askim

Sweden

Telephone: +46-(0)31-68 69 99

E-mail: norden@mts.com

MTS Systems Limited

98 Church Street,
Hunslet,
Leeds
LS102AZ

United Kingdom

Telephone: +44 (0) 113 270 8011

E-mail: mtsuksales@mts.com

ASIA/PACIFIC

MTS Japan Ltd.

Raiden Bldg. 3F 3-22-6,
Ryogoku, Sumida-ku,
Tokyo 130- 0026

Japan

Telephone: +81 3 5638 0850

E-mail: mtsji-info@mts.com

MTS Korea, Inc.

2nd F, Bundang Yemiji Building, 31,
Hwangsaeul-ro 258beon-gil,
Bundang-gu, Seongnam-si,
Gyeonggi-do, 13595

Korea

Telephone: +82-31-728-1600

E-mail: mtsk-info@mts.com

MTS Systems (China) Co., Ltd.

Floor 34, Building B,
New Caohejing International
Business Center,
No.391, Guiping Road,
Xuhui District
Shanghai 200233

P.R.China

Telephone: +021-24151000

Market: +021-24151111

Sales: +021-24151188

Service: +021-24151198

E-mail: MTSC-Info@mts.com

MTS Testing Solutions India Pvt Ltd.

No. 38, Ground Floor, Donata Radiance,
1st Cross, Tavarekere Main Road,
DRC Post, Krishna Nagar Industrial Layout,
Kormangala, Bangalore – 560 029

India

Telephone: + 91 80 46254100

Email: mts.india@mts.com



MTS Systems Corporation

14000 Technology Drive
Eden Prairie, MN 55344-2290 USA

ISO 9001 Certified QMS
<http://www.mts.com>

MTS and MTS Acumen are registered trademarks of MTS Systems Corporation within the United States. These trademarks may be protected in other countries. RTM No. 211177.

© 2024 MTS Systems Corporation
100-396-864j Extensometer • Printed in U.S.A. • 06/24